

# **marantz®**

**Model SR6200 User Guide**

---

AV Surround Receiver

## ENGLISH

### WARRANTY

For warranty information, contact your local Marantz distributor.

#### RETAIN YOUR PURCHASE RECEIPT

Your purchase receipt is your permanent record of a valuable purchase. It should be kept in a safe place to be referred to as necessary for insurance purposes or when corresponding with Marantz.

#### IMPORTANT

When seeking warranty service, it is the responsibility of the consumer to establish proof and date of purchase. Your purchase receipt or invoice is adequate for such proof.

#### FOR U.K. ONLY

This undertaking is in addition to a consumer's statutory rights and does not affect those rights in any way.

## FRANÇAIS

### GARANTIE

Pour des informations sur la garantie, contacter le distributeur local Marantz.

#### CONSERVER L'ATTESTATION D'ACHAT

L'attestation d'achat est la preuve permanente d'un achat de valeur. La conserver en lieu sûr pour s'y reporter aux fins d'obtention d'une couverture d'assurance ou dans le cadre de correspondances avec Marantz.

#### IMPORTANT

Pour l'obtention d'un service couvert par la garantie, il incombe au client d'établir la preuve de l'achat et d'en corroborer la date. Le reçu ou la facture constituent des preuves suffisantes.

## DEUTSCH

### GARANTIE

Bei Garantiefragen wenden Sie sich bitte an Ihren Marantz-Händler.

#### HEBEN SIE IHRE QUITTING GUT AUF

Die Quittung dient Ihnen als bleibende Unterlage für Ihren wertvollen Einkauf. Das Aufbewahren der Quittung ist wichtig, da die darin enthaltenen Angaben für Versicherungswecke oder bei Korrespondenz mit Marantz angeführt werden müssen.

#### WICHTIG!

Bei Garantiefragen muß der Kunde eine Kaufunterlage mit Kaufdatum vorlegen. Ihren Quittung oder Rechnung ist als Unterlage ausreichend.

## NEDERLANDS

### GARANTIE

Voor inlichtingen omtrent garantie dient u zich tot uw plaatselijke Marantz.

#### UW KWITANTIE, KASSABON E.D. BEWAREN

Uw kwitantie, kassabon e.d. vormen uw bewijs van aankoop van een waardevol artikel en dienen op een veilige plaats bewaard te worden voor evt. verwijzing bijv. in verbend met verzekering of bij correspondentie met Marantz.

#### BELANGRIJK

Bij een evt. beroep op de garantie is het de verantwoordelijkheid van de consument een gedateerd bewijs van aankoop te tonen. Uw kassabon of factuur zijn voldoende bewijs.

## ESPAÑOL

### GARANTIA

Para obtener información acerca de la garantía póngase en contacto con su distribuidor Marantz.

#### GUARDE SU RECIBO DE COMPRA

Su recibo de compra es su prueba permanente de haber adquirido un aparato de valor. Este recibo deberá guardarlo en un lugar seguro y utilizarlo como referencia cuando tenga que hacer uso del seguro o se ponga en contacto con Marantz.

#### IMPORTANTE

Quando solicitar el servicio otorgado por la garantía el usuario tiene la responsabilidad de demostrar cuándo efectuó la compra. En este caso, su recibo de compra será la prueba apropiada.

## ITALIANO

### GARANZIA

L'apparecchio è coperto da una garanzia di buon funzionamento della durata di un anno, o del periodo previsto dalla legge, a partire dalla data di acquisto comprovata da un documento attestante il nominativo del Rivenditore e la data di vendita. La garanzia sarà prestata con la sostituzione o la riparazione gratuita delle parti difettose.

Non sono coperti da garanzia difetti derivanti da uso improprio, errata installazione, manutenzione effettuata da personale non autorizzato o, comunque, da circostanze che non possano riferirsi a difetti di funzionamento dell'apparecchio. Sono inoltre esclusi dalla garanzia gli interventi inerenti l'installazione e l'allacciamento agli impianti di alimentazione.

Gli apparecchi verranno riparati presso i nostri Centri di Assistenza Autorizzati. Le spese ed i rischi di trasporto sono a carico del cliente.

La casa costruttrice declina ogni responsabilità per danni diretti o indiretti provocati dalla inosservanza delle prescrizioni di installazione, uso e manutenzione dettagliate nel presente manuale o per guasti dovuti ad uso continuato a fini professionali.

## PORTUGUÊS

### GARANTIA

Para informações sobre a garantia, contactar o distribuidor Marantz local.

#### GUARDAR O RECIBO DE COMPRA

O recibo é o registo permanente da compra que fez. Deve ser guardado num local seguro, para ser apresentado em questões relacionadas com o seguro ou para quando tiver de contactar a Marantz.

#### IMPORTANTE

Quando procurar assistência técnica ao abrigo da garantia, é da responsabilidade do consumidor estabelecer a prova e data de compra.

O recibo é prova adequada.

## SVENSKA

### GARANTI

För information om garantin, kontakta Marantz lokalgagent.

#### SPAR KVITTOT

Kvittot är ett inköpsbevis på en värdefull vara. Det skall förvaras säkert och hänvisas till vid försäkringsfall eller vidkorrespondens med Marantz.

#### VIKTIGT

Fö att garantin skall gälla är det kundens sak att framställa bevis och datum om köpet. Kvitto eller faktura är tillräckligt bevis för detta.

## DANSK

### GARANTI

Henvend dem til Deres MARANTZ-forhandler angående information om garantien.

#### GEM DERES KVITTERING

Deres købskvittering er Deres varige bevis på et dyrt køb. Den bør gemmes godt og anvendes som bevis, hvis De vil tegne en forsikring, eller hvis De kommunikerer med Marantz.

#### VIGTIGT

Det påhviler forbrugeren at skaffe bevis for købet og købsdatoen, hvis han eller hun ønsker garantiservice. Deres købskvittering eller faktura er et fuldgdydigt bevis herpå.

# CE MARKING

- English**  
The SR6200 is in conformity with the EMC directive and low-voltage directive.
- Français**  
Le SR6200 est conforme à la directive EMC et à la directive sur les basses tensions.
- Deutsch**  
Das Modell SR6200 entspricht den EMC-Richtlinien und den Richtlinien für Niederspannungsgeräte.
- Nederlands**  
De SR6200 voldoet aan de EMC eisen en de vereisten voor laag-voltage.
- Español**  
El SR6200 está de acuerdo con las normas EMC y las relacionadas con baja tensión.
- Italiano**  
Il SR6200 è conforme alle direttive CEE ed a quelle per i bassi voltaggi.
- Português**  
O SR6200 conforma com as diretrizes EMC e de baixa voltagem.
- Svenska**  
SR6200 är tillverkad i enlighet med EMC direktiven och direktiven för lågvoltsutrusning.
- Dansk**  
Model SR6200 er i overensstemmelse med EMC-direktivet og direktivet om lavspænding.

## English

To ventilate the unit, do not install the unit in a rack or bookshelf, and note the followings.

- Do not touch the top of the enclosure during operation.
- Do not block the openings in the enclosure during operation.
- Do not insert objects beneath the unit.
- Do not block the ventilation slots at the top of the unit.
- Do not place anything about 1 meter above the top panel.
- Make a space of about 0.2 meter around the unit.

## Français

Pour que l'appareil puisse être correctement ventilé, ne pas l'installer dans un meuble ou une bibliothèque et respecter ce qui suit.

- Ne pas toucher le dessus du coffret.
- Ne pas obstruer les ouïes de ventilation du coffret pendant le fonctionnement.
- Ne placer aucun objet sous l'appareil.
- Ne pas obstruer les ouïes de ventilation du panneau supérieur. Ne placer aucun objet à moins d'un mètre environ du panneau supérieur.
- Veiller à ce qu'aucun objet ne soit à moins de 0,2 mètre des côtés de l'appareil.

## Deutsch

Um eine einwandfreie Belüftung des Geräts zu gewährleisten, darf das Gerät nicht in einem Gestell oder Bücherregal aufgestellt werden; die folgenden Punkte sind besonders zu beachten:

- Während des Betriebs das Oberteil des Gehäuses nicht berühren.
- Während des Betriebs die Öffnungen im Gehäuse nicht blockieren.
- Keine Gegenstände in das Gerät einführen.
- Die Belüftungsschlitze an der Oberseite des Geräts dürfen nicht blockiert werden. Darauf achten, daß über dem Gerät ein Freiraum von mindestens 1 meter vorhanden ist.
- Auf allen Geräteseiten muß ein Zwischenraum von ungefähr 0,2 meter vorhanden sein.

## Nederlands

Installeer het toestel niet in een rek of boekenkast waar de ventilatie mogelijk wordt gehinderd. Let tevens op de volgende punten:

- Raak de bovenkant van het toestel niet aan als het in gebruik is.
- Blokkeer de openingen van het toestel niet als het in gebruik is.
- Plaats geen onderwerpen onder het toestel.
- Blokkeer de ventilatie-openingen aan de bovenkant van het toestel niet. Zorg dat er tenminste 1 meter vrije ruimte boven het toestel is.
- Zorg dat er 0,2 meter vrije ruimte rond het toestel is.

## Español

Para ventilar la unidad no la instale en una estantería ni estante para libros, y tenga en cuenta lo siguiente:

- No toque la parte superior de la caja durante el funcionamiento.
- No tape las ranuras en la caja durante el funcionamiento.
- No ponga objetos debajo de la unidad.
- No tape las ranuras de ventilación de la parte superior de la unidad. No ponga nada a menos de 1 metro por encima del panel superior.
- Deje un espacio de unos 0,2 metro alrededor de la unidad.

## Italiano

Perché l'unità possa essere sempre ben ventilata, non installarla in scaffali o librerie e tenere presente quanto segue.

- Non toccare la parte superiore del rivestimento durante il funzionamento.
- Non bloccare le aperture sul rivestimento durante il funzionamento.
- Non inserire oggetti al di sotto dell'unità.
- Non bloccare le fessure di ventilazione sopra l'unità. Non posare nulla per circa un metro sopra il pannello superiore.
- Lasciare 0,2 metro liberi tutto intorno l'unità.

## Português

Para ventilar o aparelho, não instalá-lo dentro duma estante ou algo similar, e observar as seguintes recomendações:

- Não tocar a parte superior do aparelho durante a operação.
- Não bloquear as aberturas do aparelho durante a operação.
- Não inserir objectos debaixo do aparelho.
- Não bloquear as aberturas de ventilação na parte de cima do aparelho. Deixar um espaço completamente livre de cerca de 1 metro acima do painel superior.
- Deixar um espaço de cerca de 0,2 metro ao redor do aparelho.

## Svenska

För att ventilera enheten, ställ den inte i ett ställ eller bokhylla och tänk på följande.

- Vidrör inte ytterhöljets ovansida under pågående drift.
- Blockera inte öppningarna i ytterhöljet under pågående drift.
- Stick inte in föremål under enheten.
- Blockera inte ventilationshålen ovanpå enheten. Placera inte någonting närmare än 1 meter ovanför apparaten eller enheten.
- Se till att det finns omkring 0,2 meter fri plats runt omkring enheten.

## Dansk

Anbring ikke apparatet i et rack eller en boghylde, da dette kan bloke luftcirkulationen omkring apparatet. Iagttag ligeledes følgende:

- Berør ikke oversiden af kabinettet under anvendelsen.
- Bloker ikke åbningerne i kabinettet under anvendelsen.
- Stik ikke genstande ind under apparatet.
- Bloker ikke ventilationsåbningerne ovenpå apparatet. Anbring ikke noget nærmere end 1 m over apparatets overside.
- Sørg for, at der er et frit område på omkring 0,2 m omkring apparatet.

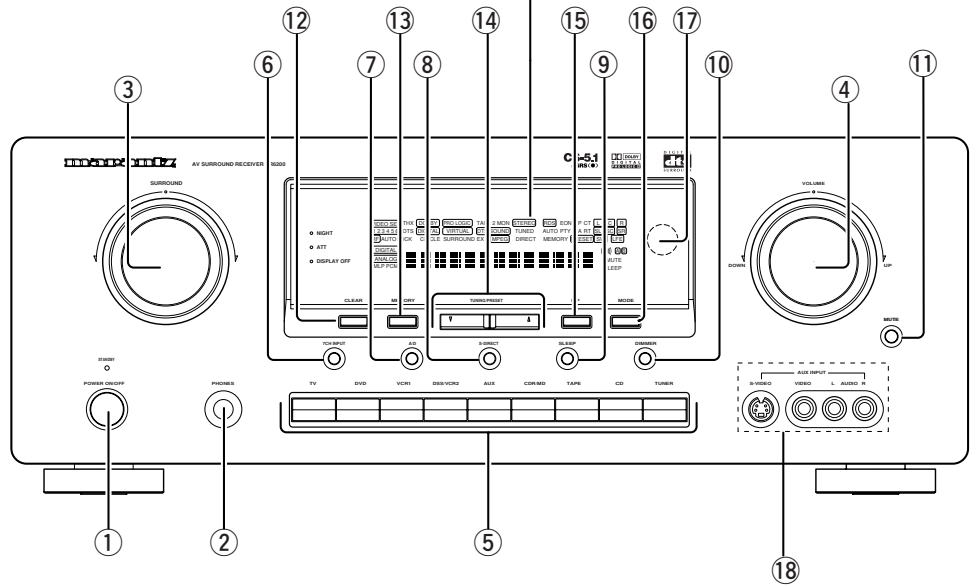
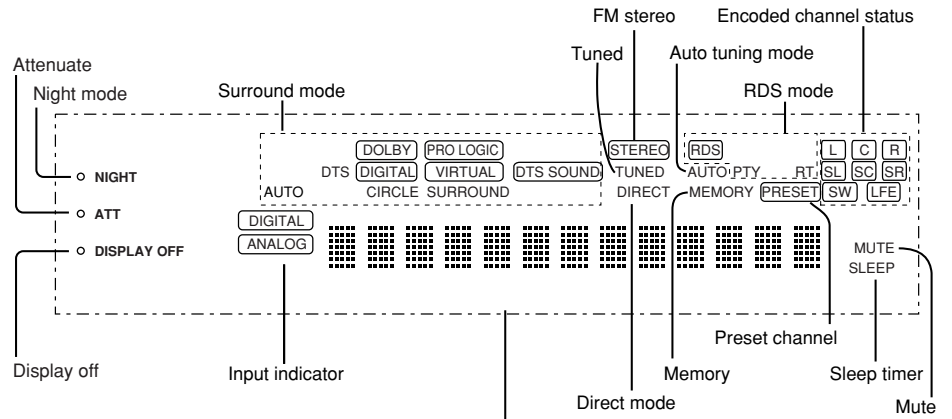
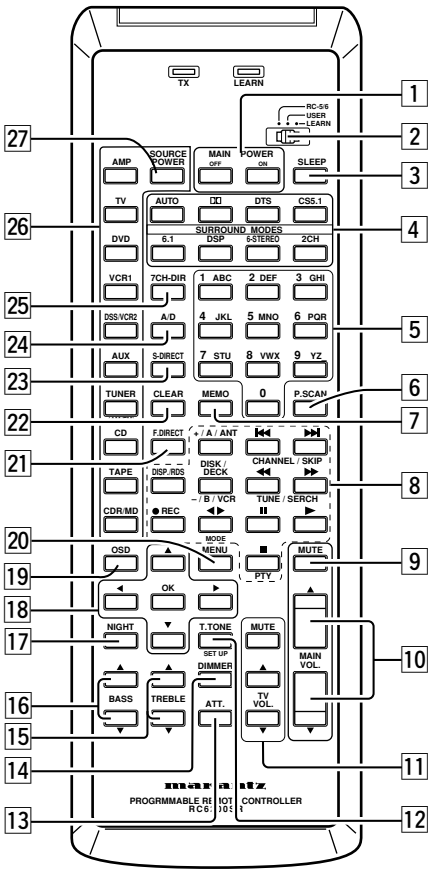
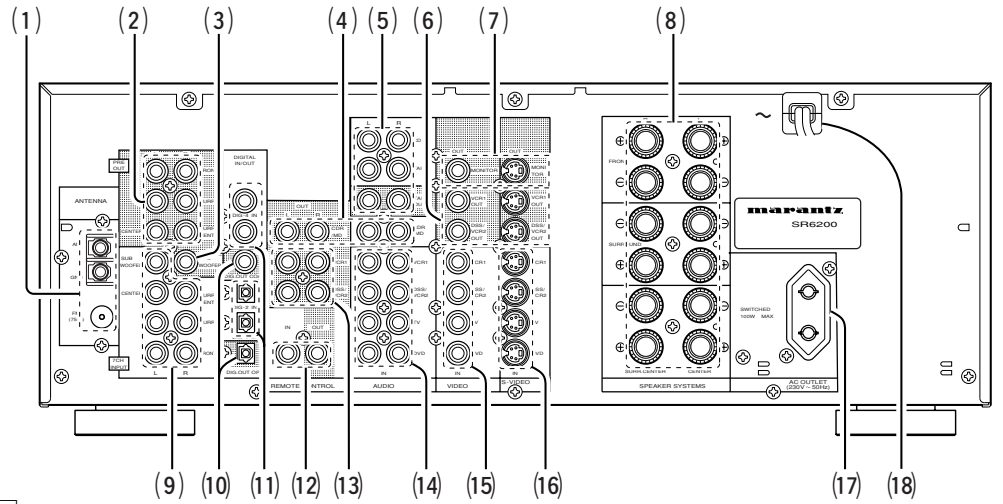

**VIDEO SYSTEM CONNECTIONS FOR VIDEO COMPONENTS**

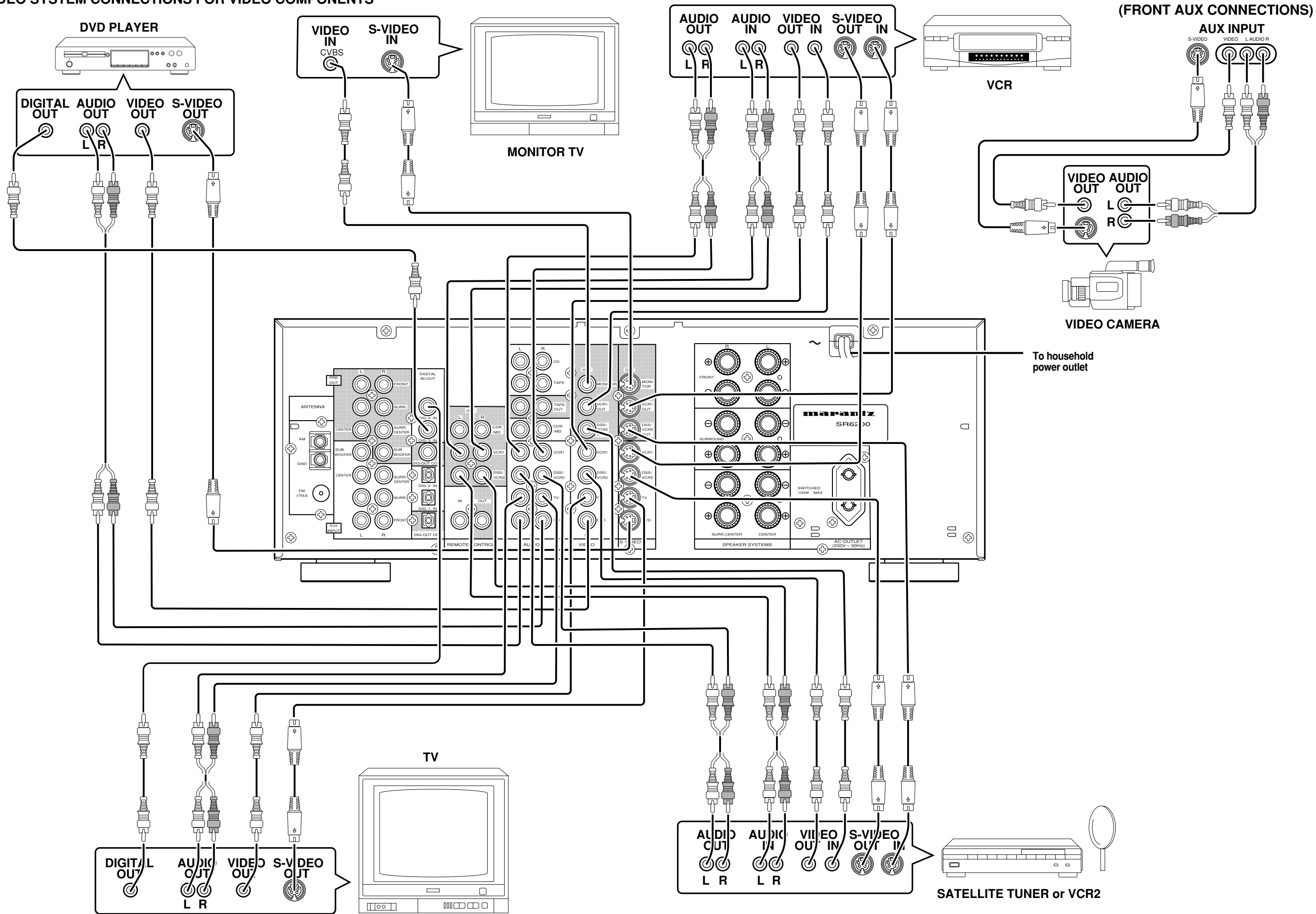

**AUDIO SYSTEM CONNECTIONS FOR AUDIO COMPONENTS**

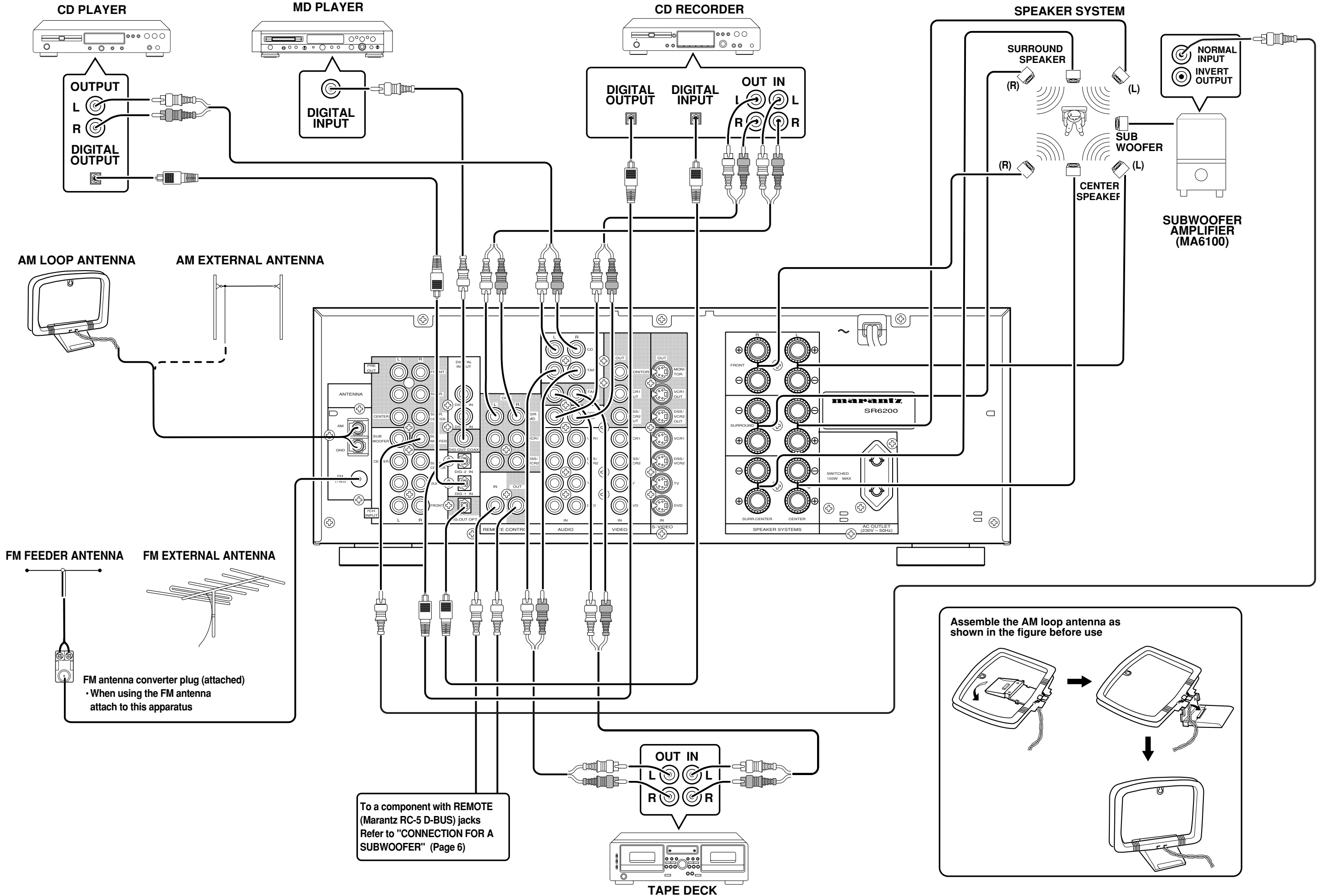

# TABLE OF CONTENTS

<b>FOREWORD</b> .....	<b>2</b>
PRECAUTIONS .....	2
<b>INTRODUCTION</b> .....	<b>3</b>
<b>DESCRIPTION</b> .....	<b>3</b>
<b>FEATURES</b> .....	<b>3</b>
<b>FRONT PANEL FEATURES</b> .....	<b>4</b>
<b>REAR PANEL CONNECTIONS</b> .....	<b>5</b>
<b>REMOTE CONTROL OPERATION (RC6200SR)</b> .....	<b>7</b>
OPERATION .....	7
FUNCTION AND OPERATION .....	7
LEARNING METHOD .....	9
LEARNABLE NUMBER OF BUTTONS .....	10
OPERATION OF REMOTE CONTROL UNIT .....	11
<b>SET-UP</b> .....	<b>12</b>
ON SCREEN DISPLAY MENU SYSTEM .....	12
OSD MAIN MENU .....	13
SYSTEM SETUP .....	13
SPEAKERS SETUP .....	14
SURROUND MODE .....	15
CHANNEL LEVEL CONTROL .....	15
<b>BASIC OPERATION</b> .....	<b>16</b>
LISTENING TO THE TUNER .....	16
RDS OPERATION .....	17
PLAYBACK OPERATION .....	18
TV AUTO ON/OFF FUNCTION .....	18
SETTING THE SLEEP TIMER .....	18
<b>ON SCREEN DISPLAY INFORMATION</b> .....	<b>19</b>
<b>SURROUND MODES</b> .....	<b>21</b>
<b>TROUBLE SHOOTING</b> .....	<b>23</b>

## FOREWORD

This section must be read before any connection is made to the mains supply.

### WARNINGS

Do not expose the equipment to rain or moisture.  
Do not remove the cover from the equipment.  
Do not push anything inside the equipment through the ventilation holes.  
Do not handle the mains lead with wet hands.

### EQUIPMENT MAINS WORKING SETTING

Your Marantz product has been prepared to comply with the household power and safety requirements that exist in your area. SR6200 can be powered by 230 V AC only.

### IMPORTANT: (FOR UK VERSION)

This apparatus is fitted with an approved moulded 13 Amp plug. To change a fuse in this type of plug proceed as follows:

1. Remove fuse cover and fuse.
2. Fix new fuse which should be a BS1362 13A, A.S.T.A. or BSI approved type.
3. Refit the fuse cover.

If the fitted plug is not suitable for your socket outlets, it should be cut off and an appropriate plug fitted in its place.

If the mains plug contains a fuse, this should have a value of 13A. If a plug without a fuse is used, the fuse at the distribution board should not be greater than 5A.

#### Note:

The severed plug must be destroyed to avoid a possible shock hazard should it be inserted into a 13A socket elsewhere.

### HOW TO CONNECT A PLUG

The wires in the mains lead are coloured in accordance with the following code:

BLUE—"NEUTRAL" ("N")

BROWN—"LIVE" ("L")

1. The BLUE wire must be connected to the terminal which is marked with the letter "N" or coloured BLACK.
2. The BROWN wire must be connected to the terminal which is marked with the letter "L" or coloured RED.
3. Do not connect either wires to the earth terminal in the plug which is marked by the letter "E" or by the safety earth symbol or coloured green or green-and-yellow.

Before replacing the plug cover, make certain that the cord grip is clamped over the sheath of the lead — not simply over the two wires.

### COPYRIGHT

Recording and playback of any material may require consent. For further information refer to the following:

- Copyright Act 1956
- Dramatic and Musical Performers Act 1958
- Performers Protection Acts 1963 and 1972
- any subsequent statutory enactments and orders

### ABOUT THIS USER GUIDE

Refer to the figures on page iii of this user guide. The numbers on the figures correspond to those in the text. All references to the connections and controls that are printed in **BOLD** type are as they appear on the unit.

## PRECAUTIONS

The following precautions should be taken when operating the equipment.

### GENERAL PRECAUTIONS

When siting the equipment ensure that:

- the ventilation holes are not covered;
- air is allowed to circulate freely around the equipment
- it is on a vibration free-surface;
- it will not be exposed to interference from an external source;
- it will not be exposed to excessive heat, cold, moisture or dust;
- it will not be exposed to direct sunlight;
- it will not be exposed to electrostatic discharges

Never place heavy objects on the equipment.

If a foreign body or water does enter the equipment, contact your nearest dealer or service centre.

Do not pull out the plug by pulling on the mains lead, hold the plug. It is advisable when leaving the house, or during a thunderstorm, to disconnect the equipment from the mains supply.

### PRECAUTIONS IN CONNECTION

- Be sure to unplug the power cable from the AC outlet or turn off the POWER switch before proceeding with any connection.
- Connect one cable at a time observing the "input" and "output".  
This will avoid any cross connection between channels and signal inputs and outputs.
- Insert the plugs securely. Incomplete connection may result in noise.
- Prior to connecting other audio and video equipment to the SR6200, please read their owner's manuals.

### INSTALLATION

If this unit or another electronic device incorporating a microcomputer is used at the same time with the tuner or television, picture disturbance or noise may occur. In such a case, install the unit according to the following guide points.

- Separate the unit as far as possible from the television.
- Place the antenna wire for the tuner or TV apart from the power cable and audio and video connection cables of this unit.
- Since the phenomenon is likely to occur when using an indoor antenna and/or 300-ohm feeder wire, we recommend using an outdoor antenna and 75-ohm coaxial cable.



## INTRODUCTION

Thank you for purchasing the Marantz SR6200 DTS/Dolby Digital Surround receiver.

This remarkable component has been engineered to provide you with many years of home theater enjoyment.

Please take a few minutes to read this manual thoroughly before you connect and operate the SR6200.

As there are a number of connection and configurations options, you are encouraged to discuss your own particular home theater setup with your Marantz A/V specialist dealer.

## DESCRIPTION



DTS was introduced in 1994 to provide 5.1 channels of discrete digital audio into home theater systems.

DTS brings you premium quality, discrete multi-channel digital sound to both movies and music.

DTS is a multi-channel sound system designed to create full range digital sound reproduction.

The no compromise DTS digital process sets the standard of quality for cinema sound by delivering an exact copy of the studio master recordings to neighborhood and home theaters.

Now, every moviegoer can hear the sound exactly as the moviemaker intended.

DTS can be enjoyed in the home for either movies or music on DVD's, LD's, and CD's.



Dolby Digital lets you enjoy Digital TV, Digital Satellite as well as DVD, LD software in digital surround, which is the next step above Dolby Pro Logic. In Comparison with Dolby Pro Logic, Dolby Digital can provide separate left surround and right surround channels, for more precise localization of sound and a more convincing, realistic ambience.

And, with Dolby Digital all five main channels can be full ranged and a subwoofer can be added to each channel, if desired.

By providing up to 5.1 channels of digital audio independently. Dolby Digital lets you enjoy better sound quality and more powerful presence than conventional Dolby Surround.

Pro Logic II, the next generation in Dolby Surround Pro Logic technology, brings the excitement of surround sound to any existing stereo mix, while making existing Dolby Surround mixes sound more like discrete 5.1-channel surround sound. It works with CDs, VHS tapes and TV shows, and MP3 files and radio broadcasts-converting all of these source to surround sound, without the artifacts by other matrix-decoding technologies.



Circle Surround is backward compatible, such that surround playback is possible from any stereo or passive matrix-encoded material.

Five full-bandwidth, discrete channels of information can be extracted from an enormous library of material not multi-channel encoded. These sources include many of today's DVDs and laser discs, as well as most all video tape, VCD, Compact Disc, radio and television broadcast material.

"Dolby", "Pro Logic", and the double-D symbol are trademarks of Dolby Laboratories.

"DTS", "ES" and "DTS Digital Surround" are trademarks of Digital Theater Systems, Inc.

Circle Surround and the  symbol are trademarks of SRS Labs, Inc. Circle Surround technology is incorporated under license from SRS Labs, Inc.

## FEATURES

- Dolby Digital and DTS surround sound decoding, plus Dolby Pro LogicII decoding, Circle Surround and a variety of additional surround modes.
- 6.1 channel mode reproduces the original 6.1 channel soundfield by extracting the surround back signal from surround left and surround right channels.
- 96 kHz/ 24 bit decoding for highest possible fidelity and bandwidth, and high-resolution playback of 96 kHz/ 24 bit PCM audio sources.
- 110 watts to each of the six main channels; the power amp section features advanced, premium high-storage power supply capacitors, and fully discrete output stages housed in cast aluminum heat sinks.
- 6.1 channel pre-amp outputs for connection to external components such as a subwoofer and external power amplifiers.
- Seven-channel direct inputs accommodate future surround sound formats or an external digital decoder.
- 4 Digital inputs, for connection to other sources, such as DVD, DSS, CD, CD-R or MD.
- 2 Digital outputs for connection to CD-R or MD.
- High-quality AM (MW/LW) /FM tuner with 30 station presets.
- Source Direct switch bypasses, tone controls and bass management for purest audio quality.
- S-video and composite video switching .
- On- Screen- Display with both Composite and "S" video.
- Front panel A/V inputs, with S-video .
- Easy to use, on-screen menu.
- Supplied with RC6200SR Programmable Learning Remote Control.
- Radio Data System (RDS) provides information on FM broadcasts.

## FRONT PANEL FEATURES (SEE PAGE iii.)

### ① POWER switch and STANDBY indicator

Press the button to turn the power ON, and press again to turn it OFF. If the **POWER** switch is in the ON position, the power of this unit can be turned ON/OFF by pressing the **POWER** button on the remote control unit.

When this unit is in the standby mode with the **POWER** switch set to the ON position, pressing one of the **FUNCTION SELECTOR** buttons also allows to turn the power on.

The **STANDBY** indicator lights up when this unit is in the standby mode (power OFF) by the remote control unit.

### ② PHONES jack for stereo headphones

Conventional dynamic headphones can be plugged in here.

#### Notes:

When using headphones, the surround mode is switched automatically to STEREO and the sound from the speakers is muted.

The surround mode returns to the previous setting as soon as the plug is removed from the jack.

### ③ SURROUND MODE Selector knob

When this knob is turned, the surround mode is switched in the following sequence.

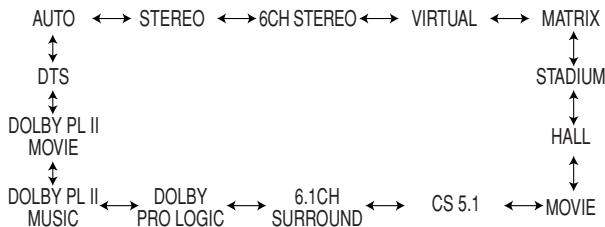

#### Note:

Not all modes will be present if an analog input is selected.

### ④ VOLUME control knob

Adjusts the overall sound level. Turning the control clockwise increases the sound level.

### ⑤ FUNCTION SELECTOR buttons (AUDIO/VIDEO)

These buttons are used to select the sources.

The video function selector, such as TV, DVD, VCR1, DSS/VCR2, and AUX, selects video and audio simultaneously.

Audio function sources such as CD, TAPE, CDR/MD, and TUNER may be selected in conjunction with a Video source.

This feature (Sound Injection) combines a sound from one source with a picture from another.

Choose the video source first, and then choose a different audio source to activate this function.

### ⑥ 7CH INPUT button

Press this button to select the output of an external multi channel decoder.

### ⑦ A/D (Analog/Digital) SELECTOR button

This is used to select between the analog and digital inputs.

#### Note:

This button is not used for an input source that is not connected to a digital input.

### ⑧ S. ( Source) DIRECT button

When this button is pressed, the tone control circuit is bypassed as well as Bass Management.

#### Notes:

The surround mode is automatically switched to AUTO when the source direct function is turned on.

Additionally, Speaker Configurations are fixed automatically as follow.

Front SPKR = Large

Center SPKR = Large

Surround SPKR = Large

Surround Center SPKR = Yes

Sub woofer = Yes

### ⑨ SLEEP button

Set the sleep timer function with this button .

### ⑩ DIMMER button

When this button is pressed once, the display is dimmed.

When this button is pressed twice, the display is turned off and "DISPLAY OFF" indicator lights up.

Press this button again to turn the display ON again.

### ⑪ MUTE button

Press this button to mute the output to the speakers. Press it again to return to the previous volume level.

### ⑫ CLEAR button

Press this button to cancel the station memory setting mode or preset scan tuning.

### ⑬ MEMORY button

Press this button to enter the tuner preset memory numbers and station names.

### ⑭ TUNING / PRESET UP and DOWN buttons

During reception of AM (MW/LW) or FM, you can scan the other frequencies or select another preset station pressing these buttons.

### ⑮ FREQUENCY / PRESET button

During reception of AM (MW/LW) or FM, you can change the function of the UP/DOWN buttons for scanning frequencies or selecting preset stations by pressing this button.

### ⑯ FM MODE button

Press this button to select the auto stereo mode or mono mode when the FM band is selected. The AUTO indicator lights in the auto stereo mode.

### ⑰ INFRARED SENSOR window

This window receives infrared signals from the remote control unit.

### ⑱ AUX input jacks

These auxiliary video/audio input jacks accept the connection of a camcorder, portable VCR, etc.

## REAR PANEL CONNECTIONS (SEE PAGE iii.)

All connections to the rear panel should be made with the entire system powered off.

To avoid errors, it is advisable to connect one cable at a time between the various components.

### (1) FM antenna terminal (75 ohms)

Connect an external FM antenna with a coaxial cable, or a cable network FM source.

#### AM (MW/LW) antenna and ground terminals

Connect the supplied AM (MW/LW) loop antenna. Use the terminals marked "AM" and "GND".

The supplied AM (MW/LW) loop antenna will provide good AM (MW/LW) reception in most areas.

Position the loop antenna until you hear the best reception.

### (2) PRE OUT jacks

Jacks for Front - L/R, Center, Surround and Surround center. Use these jacks for connection to an external power amplifier.

### (3) SUB WOOFER output jack

Connect to the input jack(s) of the power amplifier for subwoofer channel or powered subwoofer.

### (4) Analog audio outputs for audio source equipment

#### TAPE and CD-R/MD

Connect each output to the audio inputs (REC in) of your recording equipment.

### (5) Analog audio inputs

#### CD, TAPE, and CD-R/MD

Connect the audio outputs of your source components to the input jacks on the receiver.

### (6) Video outputs

#### VCR1, and DSS/VCR2

Connect each output to the video input (REC in) of your video recording equipment.

### (7) TV MONI. (VIDEO/S-VIDEO) output jacks

Connect the TV MONI jack to your TV's video input (VIDEO IN) jack. You can connect your video equipment with S-VIDEO jacks if possible, or the composite VIDEO jacks.

You must use the same type of connection from your video player into the receiver, and out of the receiver into your TV.

Both must be composite video or both must be S-Video. You cannot convert a signal from one type to the other.

When you connect to S-video connections, there will be no signal output from the composite video jacks.

### (8) SPEAKER SYSTEMS terminals

#### FRONT Left & Right speakers output terminals

Connect to the front left & right speakers.

#### CENTER speaker output terminals

Connect to the center speaker.

#### SURROUND Left & Right speakers output terminals

Connect to the surround (rear) left & right speakers.

#### SURROUND Center speakers output terminals

Connect to the surround center speakers.

### (9) 7 CH INPUT jacks

Connect to the outputs of an external multichannel decoder.

### (10) DIGITAL outputs

#### Optical and Coaxial

Connect digital input of your digital recording equipment.

### (11) DIGITAL inputs

#### Fig.1,2 (Optical) and Fig. 3, 4 (Coaxial)

Connect each input to the digital output of your source equipment.

Use the system setup menu to assign digital input to appropriate source. (see page. 13)

#### Note :

The coaxial connections are not for AC-3 RF from the LD player. If you want to decode this type of signal, an external demodulator must be used.

### (12) REMOTE CONT. IN/OUT terminals

Connect to a Marantz component equipped with remote control (RC-5) terminals.

### (13) Analog audio outputs for video source equipment

#### VCR1, and DSS/VCR2

Connect each output to the audio inputs (REC in) of your video recording equipment.

### (14) Analog audio inputs for video source equipment

#### TV, DVD, VCR1, and DSS/VCR2

Connect each input to the audio outputs of your video source equipment.

### (15) Video inputs

#### Ex: TV, DVD, VCR1, and DSS/VCR2

Connect each input to the video outputs of your video source equipment.

### (16) S-video inputs

#### Ex: TV, DVD, VCR1, and DSS/VCR2

Connect each input to the S-video outputs of your video source equipment.

### (17) AC OUTLET

Connect the power cables of components such as a DVD or CD player to this outlet.

This provides power only when the SR6200 is turned on and is useful for components which you use every time you play your system.

#### Caution:

In order to avoid potential turn-off thumps, anything plugged in here should be powered up BEFORE the SR6200 is turned on.

### (18) Power cable

Connect to AC power outlet.

SR6200 can be powered by 230V AC only.

**REMOTE CONTROL BUS CONNECTIONS**

This unit is equipped with a remote control function. By connecting this unit's remote control jacks to a Marantz CD player or tape deck equipped with remote control (RC-5) jacks, it allows system remote control to operate. Connect **REMOTE CONTROL OUT** jack of SR6200 to **REMOTE CONT. IN** of other Marantz equipment, i.e. CD player or tape deck, by using an RCA pin cable.

**Note:**  
If a component equipped with remote control (RC-5) jacks has an INT/EXT switch on the rear panel, set the switch to EXT when using the system control function.

**(Connection example)**

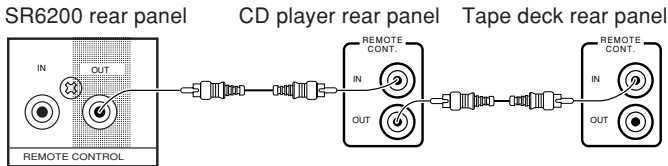

**CONNECTION FOR A SUBWOOFER**

Use this connection when using a sub-woofer speaker. You can also connect a powered subwoofer.

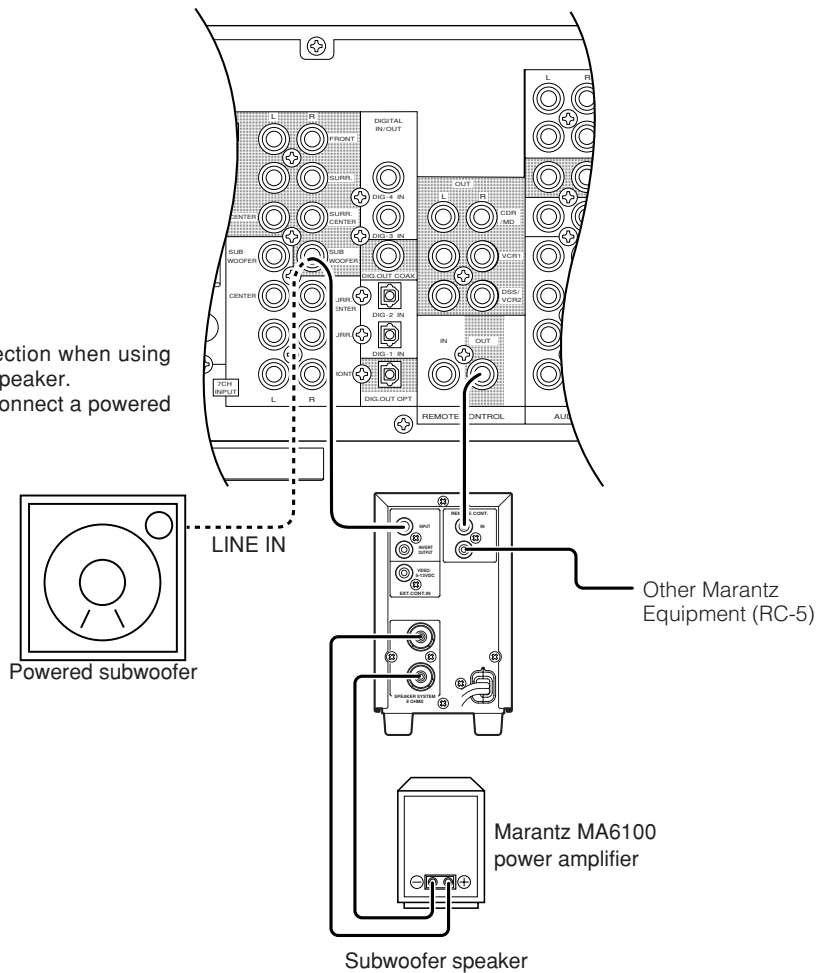

**Controlling the power ON/OFF of a power amplifier connected to the SR6200 through Marantz remote control**

1. Now the MA6100 can be turned ON / OFF in synchronism with the power ON / OFF of the SR6200.

**Notes:**

- Be sure to connect the remote control bus before the procedure above.

# REMOTE CONTROL OPERATION (RC6200SR)

- The remote control unit (RC6200SR) provided with the SR6200 is a "learning"-type, programmable unit capable of controlling almost any component in your system, as well as the Marantz D-BUS components (RC-5). The components to be controlled can be selected with one slide switch [2] and nine buttons [26], except AUX button.

## RC-5/USER/LEARN SWITCH (MODE SELECT SWITCH)

In the RC-5 position, all buttons output RC-5 codes only. In the USER position, the previously-learned remote control codes can be output, but RC-5 codes are output with buttons which have not learned any function. The LEARN position is used when programming codes under the buttons.

## OPERATION

The provided remote control unit is a system remote controller. The **POWER** button [1], 10-key numeric buttons [5] and control buttons [8] are used in common across different input source components. The input source system controlled with the remote control unit changes when one of the input selector buttons [26] is pressed.

- Example: To select the DVD player as the input source and play an DVD on it  
 Press the **DVD** button [26] twice within 2 seconds.  
 The input function of the SR6200 is switched to DVD and the remote control unit is set for control of the DVD player.  
 Press the **PLAY** ▶ button [8] to play the DVD.

# FUNCTION AND OPERATION

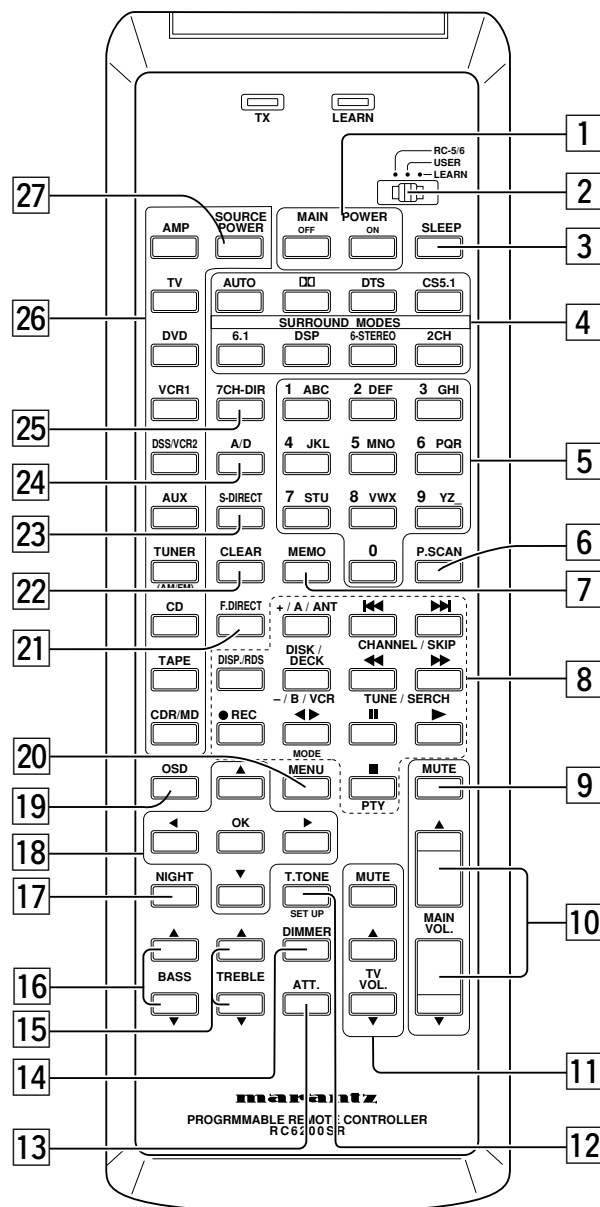

### [1] MAIN POWER buttons

Press to switch the power of the SR6200 ON or OFF.

### [2] Mode select switch

Set this switch to set the remote control mode to the RC-5 mode, USER mode or LEARN mode.

### [3] SLEEP (sleep timer) button

This button is used for setting the sleep timer.

### [4] SURROUND MODE buttons

Use these buttons to select a surround mode.

### [5] Numeric buttons 0,1 to 9 (A, B, C ... Z, -)

These buttons are used to enter figures in the selection of a tuner preset station and station name preset or to select a CD track number, etc. The functions of these buttons are dependent on the function button selected.

**6 P.SCAN (preset scan)**

This button is used to start preset scan when SR6200 is selected TUNER mode.

**7 MEMO button**

Memory enable button for various preset functions.

**8 CONTROL buttons**

These buttons are used when operating the CD player, TAPE deck, etc. The functions of these buttons are dependent on the function button selected.

For the controllable functions of each input function, please refer to Chart 1.

	TV	VCR	DVD	DSS	TUNER	CD	TAPE	CDR	MD
◀◀ CHANNEL/SKIP	CH-	PREV	PREV	CH-	CH-	PREV	PREV	PREV	PREV
▶▶ CHANNEL/SKIP	CH+	NEXT	NEXT	CH+	CH+	NEXT	NEXT	NEXT	NEXT
◀◀ TUNE/SERCH	—	REWIND	REWIND	—	TUNING-	REWIND	REWIND	REWIND	REWIND
▶▶ TUNE/SERCH	—	FF	FF	—	TUNING+	FF	FF	FF	FF
● REC	—	REC	—	—	—	—	REC	REC	REC
▶ MODE	—	—	—	—	MODE	—	DIRECTION	—	—
⏸	—	PAUSE	PAUSE	—	—	PAUSE	PAUSE	PAUSE	PAUSE
▶	—	PLAY	PLAY	—	—	PLAY	PLAY	PLAY	PLAY
+A/ANT	VIDEO	TV/VCR	DISC+	DSS/VCR	—	DISC+	DECK A	—	—
-B/VCR	VIDEO	TV/VCR	DISC+	DSS/VCR	—	DISC-	DECK B	—	—
■ PTY	—	STOP	STOP	—	RDS PTY	STOP	STOP	STOP	STOP
DISP./RDS	CH DISPLAY	—	OSD	CH DISPLAY	RDS DISPLAY	—	—	—	—

Chart 1

**9 MUTE button**

Muting button of the SR6200. Press this button to temporarily decrease the volume. Press again to return to the previous volume.

**10 MAIN VOLUME UP (▲) /DOWN (▼) buttons**

Main volume control of the SR6200. These buttons increase or decrease the front, surround center and subwoofer channel volumes simultaneously.

**11 TV operation buttons**

These buttons are used exclusively to control the TV set.

**MUTE button**

Muting of TV sound.

**TV VOLUME UP (▲)/DOWN (▼) buttons**

Volume UP/DOWN of TV.

**12 TEST (test tone) button**

Test tone function is used for adjusting the balance between the volume levels of speaker channels. Press AMP button and press this button to enter the test tone mode.

**13 ATT (attenuater) button**

ATT (Attenuater) button attenuates the AUDIO/VISUAL signal selected with the FUNCTION buttons (AUDIO, AUDIO/VIDEO). When the input signal is too great and the voice distorts even by throttling the SR6200 VOLUME control, turn on the function. "ATT" is displayed when this function is activated

The signal input level is reduced by about the half. The attenuater is invalid for use with the output signal of "REC OUT"(TAPE OUT/VCR OUT).

**14 DIMMER button**

When this button is pressed once, the display is dimmed.

When this button is pressed twice, the display is turned off and the "DISPLAY OFF" indicator lights up.

Press this button again to turn on the display again.

**15 TREBLE buttons**

These buttons are used to adjust the tone control of high frequency sound for left, center and right speaker.

**16 BASS buttons**

These buttons are used to adjust the tone control of low frequency sound for left, center right and subwoofer speaker.

**17 NIGHT button**

Pressing this button prevents the Dolby Digital signal from playback at a loud voice. This function reduces the voice by 1/3 to 1/4 at maximum. Thus, it eliminates the occurrence of an abruptly loud voice at night. However, the function is valid only in the case when the Dolby Digital signal is entered into OPTICAL or COAXIAL and data to compress the voice exists in the signal to be played back.

**18 Cursor buttons (◀, ▶, ▲, ▼, OK)**

Use these button when operating the on-screen menu functions.

See page 12.

**19 OSD (on-screen display) button**

Press this button to display the current setting status of the SR6200 on the TV screen.

Once the button is pressed, the on-screen display is turned on and each time a control button related to the SR6200 is pressed thereafter, the information will be displayed on the TV screen.

When the button is pressed again to turn the on-screen display off, it disappears from the TV screen.

(Refer to "On-screen display" on page 13.)

Holding down the OSD button for more than 3 seconds activates the video system switching mode and the current video system appears in the display. Press OSD again within the 5 seconds that the setting is displayed to switch between the following video systems.

PAL → NTSC → PAL

This unit set to PAL when shipped from the factory.

**20 MENU button**

This button is used to enter the OSD main menu.

**21 F.DIRECT button**

This button is used to inputs a frequency directly

**22 CLEAR button**

This button is used to cancel for certain memory or programming operations.

**23 S- ( Source) DIRECT button**

When this button is pressed, the tone control circuit is bypassed as well as Bass Management.

**24 A/D button**

This button is used to switch between the analog and digital inputs.

**25 7CH-DIR button**

This button is used to activates 7-channel input

## 26 Input system selector buttons/ FUNCTION SELECTOR buttons (AUDIO/ VIDEO INPUT)

Press one of these buttons once or twice to select a particular source component. For example, to set the amplifier or receiver to the DVD input, press the **DVD** button 26 twice within 2 seconds.

### Note:

**CDR/MD** button is set CDR function at initial. To switch MD function, press and hold down **CDR/MD** button and press **2** button 5.

To return CDR function, press and hold down **CDR/MD** button and press **1** button 5.

## 27 SOURCE POWER button

Press to switch the power of an individual source component ON or OFF.

For example, to turn on the DVD player, first press the **DVD** button 26 then press the **SOURCE POWER** button 27.

### Note:

All of the MARANTZ components equipped with D-BUS (RC-5) connection use the same power ON and OFF commands.

As a result, simply pressing the source power button of the remote control unit also allows you to turn the power of the components ON and OFF.

## LEARNING METHOD

This remote control unit (RC6200SR) can learn, or program in itself, the remote control code of any function preset under any button of the remote control unit of any system component, except for the **MAIN POWER** and the **FUNCTION** buttons of the RC6200SR. The functions of the components that can be controlled through the D-BUS (RC-5) need not be learned, but the functions of other components must be learned before they can be controlled from the RC6200SR remote control unit. To let the RC6200SR learn the remote control code of a function of a component, follow the learning procedure described below.

1. Set the mode switch 2 to **LEARN**.
2. Select the component with the codes to be learned, by pressing one of the input selector buttons.  
For example, when the CD button is pressed, most of the buttons on the remote control unit get ready to learn the CD control codes.
3. On the RC6200SR, press the button corresponding to the function to be learned. For example, if the function to be learned is playback, press the **PLAY** (▶) button on the remote control unit. The **LEARN** indicator will light up.
4. Place the remote control unit of the component with the function to be learned at a distance of about 20 cm (8 inches) from the RC6200SR, so that the head (transmitting side) of the former remote control unit points the head of the RC6200SR.
5. On the remote control unit of the component, press and hold the button of the function to be learned, until the learning indicator of the RC6200SR starts to blink then goes off. The learning operation is complete when the indicator is extinguished.
6. Set the mode switch to **USER**.
7. Let the RC6200SR learn other codes by repeating the steps above for each code.

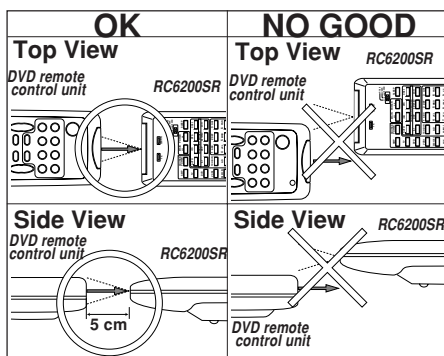

### Note:

When the system mode switch is in the **USER** position, the buttons which have not learned any function output the D-BUS (RC-5) codes when they are pressed. In the **RC-5** (D-BUS) position, all buttons output the D-BUS (RC-5) codes.

## FUNCTIONS THAT CAN BE LEARNED

The RC6200SR has buttons that can **LEARN** to 1, 4 or 10 types of different codes.

See the chart on the next page for the types of codes that can be learned by each button.

## RECALLING THE PRESET FUNCTION

Even after a button has learned the remote control code of a function, its originally preset, D-BUS (RC-5) code can be recalled any time by following the procedure below.

1. Set the mode switch to **LEARN**.
2. Press the **MAIN POWER OFF** button and the button which has learned a function simultaneously.
3. Set the mode switch to **USER**.

## Learning button indications

Although the learning buttons can be used to operate various components, the indications printed above the buttons are Marantz D-BUS (RC-5) preset code indications. To make it easier to remember which buttons perform which operations, therefore, we recommend that you program operations into buttons having the same or similar indications.

## There are some situations where programming is not possible.

In the following instances, both the TX and LEARN LEDs blink to indicate that programming cannot be carried out.

1. When the remote control unit's memory is full.
2. When you attempt to program a command from a remote control unit using a different signal transmission format.

## CLEARING ALL OF THE LEARNED CODES

Use the following procedure to reset all of the buttons which have learned remote control codes and make them possible to output RC-5 preset codes.

1. Set the mode switch to **LEARN**.
2. Hold down the **MAIN POWER ON** and **OFF** buttons simultaneously for more than 3 seconds. The TX and LEARN LED will blink and goes off.
3. Set the mode switch to **USER**.

LEARNABLE NUMBER OF BUTTONS

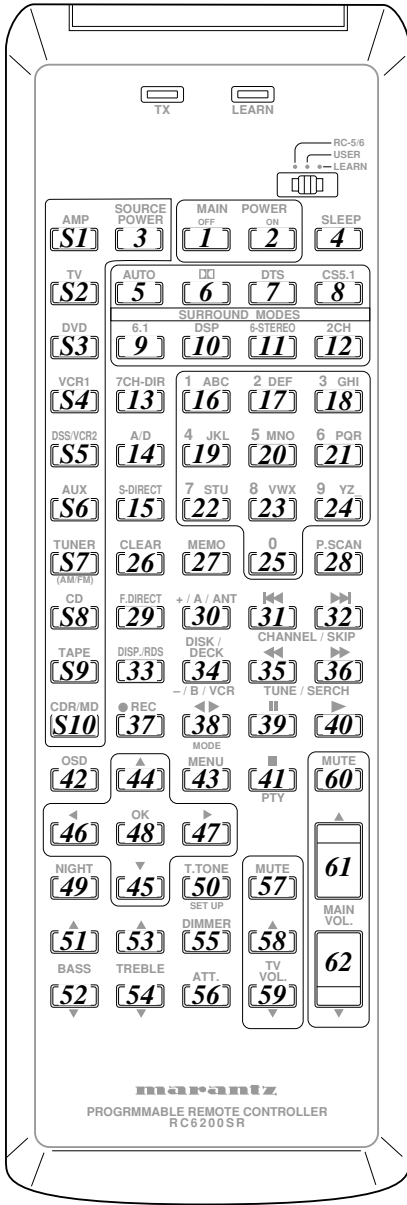

	SYSTEM KEY NO.	S1	S2	S3	S4	S5	S6	S7	S8	S9	S10	TOTAL
	SYSTEM NAME	AMP	TV	DVD	VCR1	DSS/VCR2	AUX	TUNER	CD	TAPE	CDR/MD	
1	MAIN POWER ON	(Can not learn)										0
2	MAIN POWER OFF	(Can not learn)										0
3	SOURCE POWER	1	1	1	1	1	1	1	1	1	1/1	10
4	SLEEP											1
5	AUTO											1
6	DD											1
7	DTS											1
8	CSS.1											1
9	6.1											1
10	DSP											1
11	6-STEREO											1
12	2CH											1
13	7-CH											1
14	AD											1
15	S-DIRECT											1
16	1	1	1	1	1	1	1	1	1	1	1/1	10
17	2	1	1	1	1	1	1	1	1	1	1/1	10
18	3	1	1	1	1	1	1	1	1	1	1/1	10
19	4	1	1	1	1	1	1	1	1	1	1/1	10
20	5	1	1	1	1	1	1	1	1	1	1/1	10
21	6	1	1	1	1	1	1	1	1	1	1/1	10
22	7	1	1	1	1	1	1	1	1	1	1/1	10
23	8	1	1	1	1	1	1	1	1	1	1/1	10
24	9	1	1	1	1	1	1	1	1	1	1/1	10
25	0	1	1	1	1	1	1	1	1	1	1/1	10
26	CLEAR	1	1	1	1	1	1	1	1	1	1/1	10
27	MEMO	1	1	1	1	1	1	1	1	1	1/1	10
28	P-SCAN	1	1	1	1	1	1	1	1	1	1/1	10
29	F.DIRECT	1	1	1	1	1	1	1	1	1	1/1	10
30	+ / A / ANT DISC/DECK	1	1	1	1	1	1	1	1	1	1/1	10
31	CHANNEL / SKIP ◀◀	1	1	1	1	1	1	1	1	1	1/1	10
32	CHANNEL / SKIP ▶▶	1	1	1	1	1	1	1	1	1	1/1	10
33	DISP./RDS	1	1	1	1	1	1	1	1	1	1/1	10
34	- / B / VCR DISC/DECK	1	1	1	1	1	1	1	1	1	1/1	10
35	TUNE / SEARH ◀◀	1	1	1	1	1	1	1	1	1	1/1	10
36	TUNE / SEARH ▶▶	1	1	1	1	1	1	1	1	1	1/1	10
37	● REC	0	0	0	1	1	0	0	0	1	1/1	4
38	◀▶ MODE	1	1	1	1	1	1	1	1	1	1/1	10
39		1	1	1	1	1	1	1	1	1	1/1	10
40	▶ (PLAY)	1	1	1	1	1	1	1	1	1	1/1	10
41	■	1	1	1	1	1	1	1	1	1	1/1	10
42	OSD	1	1	1	1	1	1	1	1	1	1/1	10
43	MENU	1	1	1	1	1	1	1	1	1	1/1	10
44	▲ (CURSOR)	1	1	1	1	1	1	1	1	1	1/1	10
45	▼ (CURSOR)	1	1	1	1	1	1	1	1	1	1/1	10
46	◀ (CURSOR)	1	1	1	1	1	1	1	1	1	1/1	10
47	▶ (CURSOR)	1	1	1	1	1	1	1	1	1	1/1	10
48	OK	1	1	1	1	1	1	1	1	1	1/1	10
49	NIGHT											1
50	T.TONE SET UP	1	1	1	1	1	1	1	1	1	1/1	10
51	BASS ▲											1
52	BASS ▼											1
53	TREBLE ▲											1
54	TREBLE ▼											1
55	DIMMER											1
56	ATT.											1
57	MUTE (TV VOL.)											1
58	TV VOL. ▲											1
59	TV VOL. ▼											1
60	MUTE (MAIN VOL.)											1
61	MAIN VOL. ▲											1
62	MAIN VOL. ▼											1
TOTAL												369



## OPERATION OF REMOTE CONTROL UNIT

### 1. Remote control

The distance between the transmitter of the remote control unit and the IR SENSOR of the SR6200 should be less than about 5 meters. If the transmitter is pointed to a direction other than the IR SENSOR or if there is an obstacle between them, remote control may not be possible.

#### Remote-controllable range

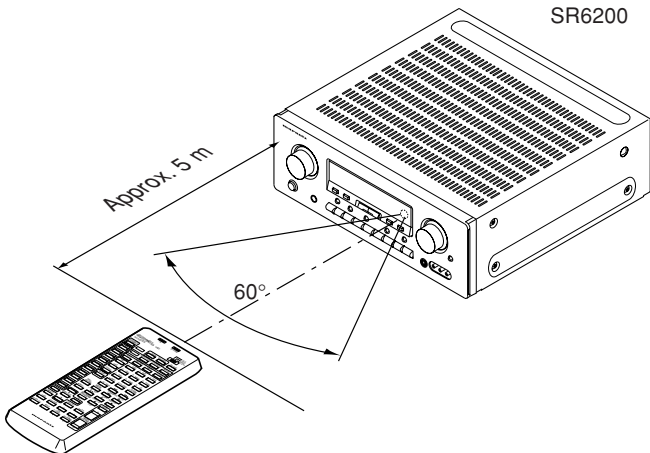

Remote control unit (RC6200SR)

### 2. Loading batteries

The life of the batteries used with the remote control unit is about 4 months with normal use. Also be sure to replace batteries earlier when you notice that they are getting weak.

#### (1) Remove the back cover.

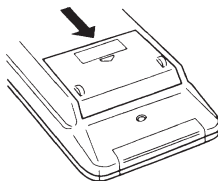

#### (2) Insert the new batteries (AAA type) with correct (+) and (-) polarity.

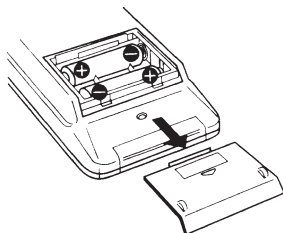

#### (3) Close until it clicks.

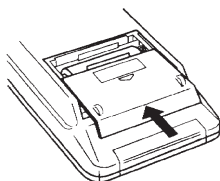

# SET-UP

After all components are connected, initial setup must be performed.

## ON SCREEN DISPLAY (OSD) MENU SYSTEM

The SR6200 incorporates an on-screen menu system, which makes various operations possible by using the cursor (◀, ▶, ▲, ▼) and OK buttons on the remote controller.

The settings made with these buttons are also shown in the on-screen display.

### OSD MAIN MENU

```

OSD MAIN MENU
▶ SURROUND MODE
CHANNEL LEVEL
SYSTEM SETUP
SPEAKER SETUP

EXIT
    
```

### SURROUND MODE

```

SURROUND MODE
▶ SOURCE DIRECT : OFF
SURR-MODE : AUTO
NIGHT MODE : OFF
LFE LEVEL : 00dB

RETURN          EXIT
    
```

### SYSTEM SETUP 1/2

```

SYSTEM SETUP 1 / 2
▶ 7CH-INPUT : OFF
TV-AUTO : DISABLE

NEXT SETUP      EXIT
    
```

### SPEAKER SETUP 1/3 SPKR SIZE

```

SETUP1/3 SPKR SIZE
▶ SETUP : UNLOCKED

FRONT-L/R : LARGE
CENTER : SMALL
SURR-L/R : SMALL
SURR. CENTER : YES
SUBWOOFER : YES

NEXT SETUP      EXIT
    
```

### CHANNEL LEVEL CONTROL

```

CH. LEVEL CONTROL
▶ FRONT L : 00 dB
FRONT R : 00 dB
SUBWOOFER : 00 dB
CENTER : 00 dB
SURROUND L : 00 dB
SURROUND R : 00 dB
SURR. CENTR : 00 dB

RETURN          EXIT
    
```

### SYSTEM SETUP 2/2

```

SYSTEM SETUP 2 / 2
▶ CD : DIG1
CD-R : DIG2
DVD : DIG3
TV : DIG4
DSS : ANA

RETURN          EXIT
    
```

### SPEAKER SETUP 2/3 SPKR DISTANCE

```

SETUP2/3 SPKR DISTANCE
▶ UNIT : ft
FRONT-L : 10 ft
FRONT-R : 10 ft
CENTER : 10 ft
SURROUND-L : 10 ft
SURROUND-R : 10 ft
ENTER

NEXT SETUP      EXIT
    
```

### SPEAKER SETUP 3/3 SPKR LEVEL

```



SETUP3/3 SPKR LEVEL
▶ TEST MODE : MANUAL
TEST TONE : OFF
FRONT-L : 00dB

■      ■      ■
■      ■      ■

RETURN          EXIT
    
```

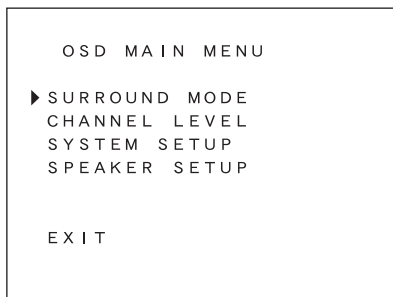
## OSD MAIN MENU



1. Press the **AMP** button .
2. Press the **MENU** button  to display the "MAIN MENU" of the on-screen display menu.  
Choose a desired item in the contents with **▲** or **▼** button, and press the **OK** button to select.  
Display will change to menu for each item.

## SYSTEM SETUP

### SYSTEM SETUP 1/2

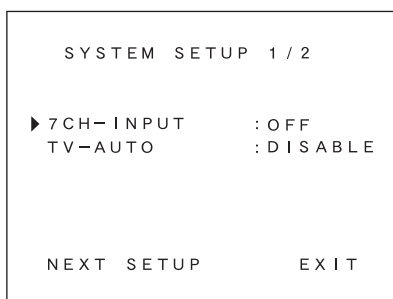

**7CH-INPUT** : The 7 channel input of the SR6200 can be selected to use a 7channel input. Select 7 channel use by **◀** or **▶** button.

**TV AUTO** : This product is equipped with a TV-auto ON/OFF system, which automatically turns on or off the power 1 second to 5 minutes after the TV video input signal has been sent or has been stopped.

Switch the TV AUTO ON/OFF function to enable or disable with **◀** or **▶** button.

To use this function, connect the TV video input to TV tuner's video output.

**NEXT SETUP/EXIT** : If you desire to continue the next setup ,press the **OK** button on NEXT-SETUP, if you desire to exit from OSD menu system, press the **OK** button on EXIT.

### SYSTEM SETUP 2/2 (SELECTING THE DIGITAL INPUT)

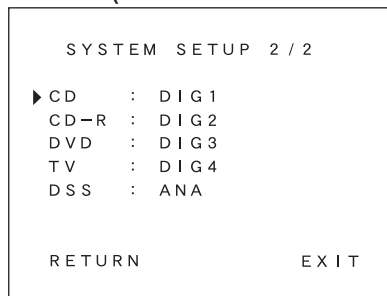

Four digital inputs can be assigned for the desired source. Use this menu to determine which source is connected to which input.

#### Example;

When the digital output of a DVD player is connected to Digital 4 (input jack) of the SR6200;

1. Move the cursor on the line of the DVD with cursor buttons **▲** or **▼**.
2. Press the cursor **◀** or **▶** button until "DIG4" is displayed.
3. Press the **OK** button to chose.
4. If you desire to continue the next setup, press the **OK** button on RETURN.  
If you desire to exit from OSD menu system, press the **OK** button on EXIT.

#### Notes:

The TUNER, TAPE, VCR1 and AUX are assigned to the analog input, and are prevented from selecting any digital input.

While the DTS-LD or DTS-CD is playing, this setup is not available, this is to avoid noise being generated from the analog input. Stop the LD or CD playback to setup.

The SR6200 does not switch from digital input to analog input or vice versa automatically.

In the event that both digital and analog inputs are connected to SR6200, if you desire to switch to an analog input temporarily, you can switch by pressing the **A/D** button .

## SPEAKERS SETUP

The home theater system you already have installed should function provided that there are left, center and right front speakers, left and right rear/surround speakers and a subwoofer. For best results we recommend that all front speakers be of the same type, with identical or similar driver units. This will deliver smooth pans across the front sound stage as the action moves from side to side.

Your center channel speaker is very important as over 80 % of the dialog from a typical motion picture emanates from the center channel. It should possess similar sonic characteristics to the main speakers. Surround channel speakers need not be identical to the front channel speakers, but they should be of high quality.

The surround center speaker is useful for playback of Dolby Digital Surround EX or DTS-ES. One of the benefits of both Dolby Digital (AC-3) and DTS is that surround channels are discrete full range, while they were frequency limited in earlier "Pro Logic" type systems. Bass effects are an important part of home theater. For optimal enjoyment a subwoofer should be used as it is optimized for low frequency reproduction. If you have full range front speakers, however, they may be used in place of a subwoofer with proper setting of the switches in the menu system.

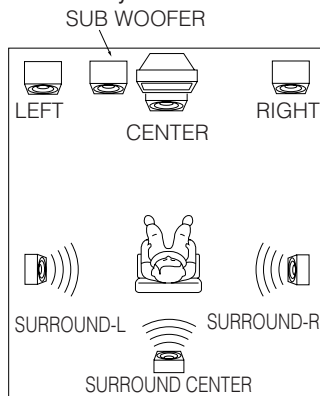

If possible, mount the surround speakers on the walls to the sides of the viewing area, 2-3 feet above seated viewers, firing straight across at each other.

### SPKR SETUP 1/3 (SPKR SIZE)

SETUP1/3	SPKR SIZE
▶ SETUP :	UNLOCKED
FRONT-L/R :	LARGE
CENTER :	SMALL
SURR-L/R :	SMALL
SURR. CENTER :	YES
SUBWOOFER :	YES
NEXT SETUP	EXIT

**SETUP:** Select "LOCKED" with ◀ or ▶ button in order to lock the contents of the SPKR SET UP MENU.

When you want to change the contents of this setup, select "UNLOCKED".

### SPKR SIZE

This menu enters the information about which type of speakers will be used for each channel.

In turn, these settings will determine which speakers receive low frequency information.

For the purpose of establishing proper bass reproduction, use the LARGE settings if the speaker being used at any position is a traditional full-range loudspeaker that is capable of reproducing sound below 100 Hz and you are not using a subwoofer.

Use the SMALL setting for smaller, frequency-limited speakers that are not able to reproduce sounds below 100Hz and you are using a subwoofer. Low frequencies will be diverted from the speaker to the subwoofer.

Note that when "small" speakers are used it is advisable to install a separate subwoofer, especially if you wish to appreciate the full impact of a good home theater soundtrack.

If the Surround speakers or Center speaker will not be used, set NONE for each speaker. The NONE setting will send the audio for the channel to other speakers.

**FRONT -L/R :** Select the type of front speakers with ◀ or ▶ button.

**CENTER :** Select the type of center speaker with ◀ or ▶ button.

**SURR-L/R :** Select the type of surround speakers with ◀ or ▶ button.

**SURR.CENTER :** Select the surround center speaker YES or NO with ◀ or ▶ button.

**SUBWOOFER:** Select the subwoofer speaker YES or NO with ◀ or ▶ button.

### Notes:

The SUBWOOFER cannot be set to NO when the front speakers are set to SMALL.

This speaker size setup is not effective when the SOURCE-DIRECT or 7CH. Input is selected.

### SPKR SETUP 2/3 (SPKR DISTANCE)

SETUP2/3	SPKR	DISTANCE
▶ UNIT :		f t
FRONT-L :		10 f t
FRONT-R :		10 f t
CENTER :		10 f t
SURROUND-L :		10 f t
SURROUND-R :		10 f t
		ENTER
NEXT SETUP		EXIT

Use this parameter to specify the distance of the speaker's position from the listener.

The delay time is automatically set according to these distances.

**UNITS:** You can select Meters or Feet.

If you select "ft", the setting parameter will change in 1 foot steps.

If you select "m", it will change in 0.3 meter steps.

Select speaker with ▲ or ▼ button, and input each speaker's distance with ◀ or ▶ button.

When the input for each speaker's distance has been finished, move the cursor to ENTER and press the OK button.

### NOTES :

If your selection(s) are out of range, the distance cannot be stored. Placement beyond that distance is beyond the range of the automatic time delay feature.

The delay feature does not function in the SOURCE-DIRECT ,7 CH-Input modes and decoding of 96 kHz sources.

### SPKR SETUP 3/3 (SPKR LEVEL)

SETUP3/3	SPKR LEVEL
▶ TEST MODE :	MANUAL
TEST TONE :	OFF
FRONT-L :	00 dB
■	■
■	■
RETURN	EXIT

### SPKR LEVEL

**TEST MODE:** Selects the mode for generating the test tone.

If you select AUTO, the test tone will be cycled through in a circular pattern which is Left → Center → Right → Surround Right → Surround Center → Surround Left → Subwoofer → Left → ... 3 seconds for each channel.

If you select MANUAL, press the OK button to select the test tone channels after the "TEST TONE ON".

**TEST TONE:** Press the ◀ or ▶ button, ON is indicated and the test tone starts from the front L-CH speaker.

Press the ◀ or ▶ button again on this item. OFF is indicated and the output of the test tone will stop.

**Channel:** Adjust the level of test tone for each channel with the ◀ or ▶ buttons of the RC6200SR. The current volume level is shown at the center of the display.

## SURROUND MODE

```

SURROUND MODE
▶ SOURCE DIRECT : OFF
SURR-MODE : AUTO
NIGHT MODE : OFF
LFE LEVEL : 00dB

RETURN          EXIT

```

**SOURCE DIRECT** : Switch the source direct ON or OFF with ◀ or ▶ button. This bypasses the surround processing and crossover for the main speakers (front left and right will be full range and the subwoofer will be ON)

**Note:** Surround mode cannot be changed in Source Direct mode.

**SURR-MODE** : Select the surround mode with ◀ or ▶ button.

**NIGHT MODE** : Switch the NIGHT MODE ON or OFF with ◀ or ▶ button.

Selecting the Night Mode ON is effective in Dolby Digital only, and it compresses the dynamic range.

This softens loud passages such as sudden explosions, to help prevent disturbing others late at night.

**LFE LEVEL** : Select the output level of the LFE signal included in the Dolby Digital signal or the DTS signal. Select 0dB, -10 dB or OFF with ◀ or ▶ button.

The level is ordinarily set to 0 dB. When use DTS music source, LFE level is set to -10 dB.

## CHANNEL LEVEL CONTROL

```

CH. LEVEL CONTROL
▶ FRONT L      : 00 dB
FRONT R       : 00 dB
SUBWOOFER     : 00 dB
CENTER        : 00 dB
SURROUND L    : 00 dB
SURROUND R    : 00 dB
SURR. CENTR   : 00 dB

RETURN          EXIT

```

Desired channels can be selected by pressing ▲ or ▼ button. Each channel level will be adjusted by pressing ◀ or ▶ button. Only the usable channels which are determined depending on the SURROUND mode, and SPEAKER SETTING are displayed.

# BASIC OPERATION

## LISTENING TO THE TUNER

### MANUAL TUNING

1. To select the tuner as the source, press the **TUNER** button ⑤ on the front panel or press the **TUNER** button ②⑥ on the remote.
2. Press the **TUNER** button ⑤ on the front panel or press the **TUNER** button ②⑥ on the remote to select the desired frequency band if required.
3. Press the **F/P** button ⑮ on the front panel to display the frequency.
4. Press the **TUNING/PRESET** ▲ or ▼ button ⑭ on the front panel or press the ◀◀ or ▶▶ button ⑧ on the remote.
5. If FM is selected, press the **MODE** button ⑯ on the front panel or press the **MODE** button ⑧ on the remote control to select the desired auto (stereo) mode.

### (FM) MODE BUTTON OPERATION

When "AUTO" indicator is on in the display, FM stations that broadcast in stereo will be received in stereo and the "STEREO" indicator lights.

When "AUTO" indicator is off, all the FM stations will be received in mono regardless of whether or not they are broadcasting in stereo.

### AUTO TUNING (USING THE SR6200)

1. Press the **F/P** button ⑮ on the front panel to display the frequency.
2. Press the **TUNING/PRESET** ▲ or ▼ button ⑭ on the front panel for more than 1 second to start the Auto tuning function.

### AUTO TUNING (USING THE REMOTE CONTROL UNIT)

Press ◀◀ or ▶▶ button ⑧ for more than 1 second to start the Auto tuning function.

### PRESET TUNING

With this unit you can preset up to 30 FM/AM (MW/LW) stations in any order. For each station, you can memorize the frequency and reception mode if desired.

#### 1-a. Manual Presetting (Using the SR6200)

1. Refer to the "MANUAL TUNING" or "AUTO TUNING" section above to tune in a desired station.
2. Press the **MEMORY** button ⑬. "MEMORY" indicator starts blinking on the display.  
While "MEMORY" is still blinking (approx. 5 seconds), select the preset number by pressing the **TUNING/PRESET** ▲ or ▼ button ⑭ then press the **MEMORY** button ⑬ again.
3. When a number has been properly input, "MEMORY" indicator stops blinking and goes out.  
The station is now stored in the specified preset memory location.

#### 1-b. Manual Presetting (Using the remote control unit)

1. Tune in a desired station.
2. Press the **MEMO** button ⑦.
3. Enter the desired preset number with ten keypad ⑤.
4. Then, press **MEMO** button ⑦ again to store.

#### 2. Auto Presetting

This function automatically scans the FM and AM (MW/LW) band and enters all stations with sufficient signal strength into the memory.

1. Press and hold down the **MEMORY** button ⑬ and **TUNER** button ⑤ simultaneously, auto presetting will start.
2. "MEMORY" will blink on the display.
3. Each time the tuner finds a station, the scanning will pause and memory. Auto presetting will start.
4. Operation stops automatically when all 30 preset memory positions are filled or when auto scanning attains the highest end of all bands.  
To stop the auto preset function at anytime, press the **CLEAR** button ⑫.

### 3. Recalling a Preset Station

1. Press the **F/P** button ⑮ to change the display to preset.
2. Select the desired preset station by pressing **TUNING/PRESET** ▲ or ▼ button ⑭ on the front panel or press **CHANNEL** button ⑧ on the remote.

#### Note:

To directly access the preset stations using the numeric keypad, select the desired preset station by entering one or two digits using the numeric keypad ⑤.

To return to the Manual Tuning mode, press the **F/P** button ⑮.

### 4. Preset Scan Tuning (Using the remote control unit)

1. Press the **P.SCAN** button ⑥ on the remote control. (The preset station with the smallest preset number is recalled first. If no stations have been preset, "NO PRESET" shows in the display and the unit returns to the previous mode.)
2. Preset stations are recalled in sequence (CH-1 → CH-2, etc.) for 5 seconds each. Preset numbers that do not contain stations are skipped.
3. You can fast forward the preset stations by pressing the **CHANNEL** ▶▶ button ⑧ continuously.  
When the desired preset station is received, cancel the preset scan operation by pressing the **CHANNEL** ◀◀ button ⑧ or the **CLEAR** button ⑫.

### 5. Clearing Preset Stations

You can remove preset stations from memory using the following procedure.

1. Recall the preset number to be cleared with the method described in "Recalling" a preset station.
2. Press the **CLEAR** button ⑫ on the front panel or **CLEAR** button ⑫ on the remote control unit for 3 seconds or more.  
"CLEAR" appears on the display to indicate that the specified preset number has been cleared.

### 6. Frequency Direct Call

1. Press **F.DIRECT** button ⑳ in the TUNER mode on the remote controller.
2. Display shows "FM- --.-- --MHz" (at FM mode).
3. Input your desired frequency with tenkeypad buttons on the remote controller.  
Eg) 98.1 MHz  
Press **9, 8, 1** and **0**
4. Press the **F.DIRECT** button ⑳ again.

### STATION NAME PRESET (On PRESET display mode)

The station name preset function allows the name of each preset channel to be entered using alphanumeric characters. The Station Name button is valid only in the tuner mode. Before station name preset operation, store stations with the preset memory operation.

1. Press the **MEMORY** button [13] on the front panel or **MEMO** button [7] on the remote for more than 3 seconds.
2. The left most column of the station name indicator flashes, indicating the character entry ready status.

#### [Operation (Using the SR6200)]

3. When you press the **TUNING/PRESET** ▲ or ▼ buttons [14] is turned, alphabetic and numeric characters will be displayed in the following order:  
**A → B → C ... Z → 1 → 2 → 3... 0 → - → + → / → (Blank) → A**  
 UP →  
 ← DOWN
4. After selecting the first character to be entered, press the **MEMORY** button [13]. The entry in this column is fixed and the next column starts to flash. Fill the next column and press the **MEMORY** button [13] for more than 1 second to confirm the entry.

#### [Operation (Using the remote control unit)]

First, press the **TUNER** button [26] on the remote control unit.

(This operation is not necessary if the remote control unit has already been operated in the TUNER mode.)

3. Enter the character using the ten keypad [5]. For example, to enter "A":  
 1) Press the "1" button. "A" appears on the display column.  
 2) Every time the 1 button is pressed, the displayed character changes in the order: **A → B → C → 1 → A...**  
 Pressing buttons other than the "1" button cause different characters to be displayed in a similar way, so that other alphanumeric characters can be entered. To enter a blank or space, press the "9" button.
4. When the desired character is displayed, press the **MEMO** button [7] to confirm the entry in this column and move to the next column. After having filled all of the 8 columns, press the **MEMO** button [7], for more than 1 second to confirm the entry.

## RDS OPERATION

Now in use in many countries, RDS (Radio Data System) is a description of the station's programming hidden space in the FM signal.

Your new receiver is equipped with RDS to assist in the selection of FM stations using station and network names, rather than broadcast frequencies. Additional RDS functions include the ability to search for programme types.

### RADIO TEXT

Some RDS stations broadcast RADIO TEXT, which is additional information on the station and programme being broadcast. RADIO TEXT information appears as 'running' text in the display. RADIO TEXT is transmitted character-by-character by the radio station. As a result of that it may take some time until the entire text has been completely received.

### RDS DISPLAY

When a receiver is tuned to an FM station that is transmitting RDS data, the Front Panel Information Display will automatically show the station name or RDS TEXT in place of the typical display of the station's broadcast frequency.

To change the display, press the **RDS** button [8] on the remote controller.

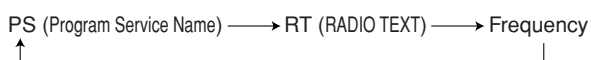

## PROGRAMME TYPE (PTY) DISPLAY

The RDS system categorizes programmes according to their genre into different programme type (PTY) groups. To display the programme type information of the current station, press the **PTY** button [8] in the TUNER MODE on the remote controller.

### PTY AUTO SEARCH

Your receiver is equipped to automatically search for stations transmitting any of 29 different programme types. To search for a PTY, follow these procedures:

1. Press the **PTY** button [8] in the TUNER MODE on the remote controller. The current station's PTY will be displayed, or the currently selected PTY group will be displayed in blinking if no station or RDS data is present.
2. To change to a new PTY type, press the **CHANNEL** button [8] until the desired PTY is shown in the display.
3. Once the desired PTY group or type has been selected, press the **PTY** button [8] while the display blink (approx. 5 seconds). The PTY Auto search will start, and the tuner will pause at each station broadcasting RDS PTY information corresponding to the selected choice.
4. To advance to the next RDS station with the desired PTY, press the **PTY** button [8] again within 5 seconds.

NUMBER	DISPLAY	PROGRAMME TYPE
1	POP	Pop Music
2	ROCK	Rock Music
3	MOR	M. O. R. Music
4	LIGHT	Light classical
5	CLASSIC	Serious classical
6	NEWS	News
7	AFFAIR	Current Affairs
8	INFO	Information
9	SPORT	Sport
10	EDUCATE	Education
11	DRAMA	Drama
12	CULTURE	Culture
13	SCIENCE	Science
14	OTHERS	Varied
15	OTHER	Other Music
16	WEATHER	Weather
17	FINANCE	Finance
18	CHILDREN	Children's programmes
19	SOCIAL	Social Affairs
20	RELIGION	Religion
21	PHONE IN	Phone In
22	TRAVEL	Travel
23	HOBBIES	Hobbies
24	JAZZ	Jazz Music
25	COUNTRY	Country Music
26	NATION	National Music
27	OLDIES	Oldies Music
28	FOLK	Folk Music
29	DOCUMENT	Documentary

## PLAYBACK OPERATION

### NORMAL PLAYBACK

1. Press the **POWER** button ① / [1].
2. Press the **FUNCTION SELECTOR** button ⑤ on the front panel or press the **FUNCTION** button [26] on the remote unit to select an input source.
3. Turn the **SURROUND MODE SELECTOR** knob ③ on the front panel or Surround mode buttons [4] in the AMP MODE on the remote unit to select the desired surround mode.
4. Adjust the volume level using the **VOLUME** knob ④ on the front panel or press the **MAIN VOL.** button [10] on the remote. If necessary, adjust the tone, press the **TREBLE▲**, **TREBLE▼** [15] and **BASS▲**, **BASS▼** [16] on the remote unit.

#### Note:

- In case of remote control operation, press one of the function buttons twice within 2 seconds to select the function.
- Tone control is available for following surround modes. AUTO (except 96 kHz), STEREO, DOLBY PRO LOGIC and DTS.

### LISTENING TO A DIFFERENT AUDIO SOURCE WHILE WATCHING A VIDEO SOURCE (Using the remote control unit)

1. Select one of the following video sources  
TV, DVD, VCR1, DSS/VCR2 or AUX.
2. Next, select one of the following audio sources  
FM, AM (MW/LW), CD, TAPE, or CDR/MD.

## TV AUTO ON/OFF FUNCTION

This function allows the component connected to the TV IN jack to control the power (ON/OFF) to the SR6200.

### AUTO POWER ON

1. Be sure TV auto mode is enable. (Refer page 13 : System Setup 1/2)
2. Connect your TV TUNER (etc) to the TV IN terminal.  
Be sure to connect the video input.
3. Turn OFF the power to the TV TUNER and the SR6200 will be in standby mode.
4. Turn ON the TV TUNER and tune in a receivable station.
5. When the station is received, the SR6200 turns ON and TV is selected automatically.

### AUTO POWER OFF

1. In the above situation, turn the TV TUNER OFF or select a channel that does not contain any broadcast.
2. The SR6200 switches to STANDBY after approximately 5 minutes.

#### Note:

AUTO POWER OFF is canceled if the **FUNCTION SELECTOR** button ⑤ is set to a source other than TV. The function reactivates when TV is selected again.

#### Caution:

Some TV broadcasts may cause the TV AUTO FUNCTION to be turned enable. To set this function to ENABLE/DISABLE, refer to the SETUP MENU.

## SETTING THE SLEEP TIMER

Set the sleep timer while the power is turned on.

1. Turn the power ON and press the **SLEEP** button ⑨ / [3].
2. Press the **SLEEP** button ⑨ / [3] the number of times to set the desired sleep time in minutes.  
Each press of the **SLEEP** button ⑨ / [3] or changes the display in the following order:

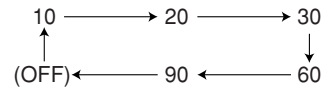

The unit will shut off in the number of minutes indicated.

- \* While the sleep timer is activated, the remaining time can be displayed for approximately 2 seconds by pressing the **SLEEP** button ⑨ / [3].
- \* To cancel the sleep timer, press the **SLEEP** button ⑨ / [3] and then press the **CLEAR** button [12] on the front panel or the **CLEAR** button [22] in the TUNER mode on the remote unit.



# ON SCREEN DISPLAY INFORMATION

The on-screen display, which can be activated by the Main unit or remote, appears on the TV screen to show the current setting status of the SR6200.

**Note:**

Each video input function is set PAL or NTSC for TV format of OSD.

If this setup does not meet the video input signal, character of OSD can not synchronize.

So You can select these format function by function.

Press **OSD** button **[19]** on the remote controller for 3 seconds or more. "PAL" or "NTSC" will be shown on the display of SR6200,

press **OSD** button **[19]** again to change the TV format. The indication on FL display will change " PAL" → " NTSC" → "PAL"→.

This setup is memorized with each video input function.

## 1. GENERAL INFORMATION

When the **OSD** button **[19]** is pressed, the current setting are displayed on the TV monitor.

This display disappears automatically in about 5 seconds after the button is pressed.

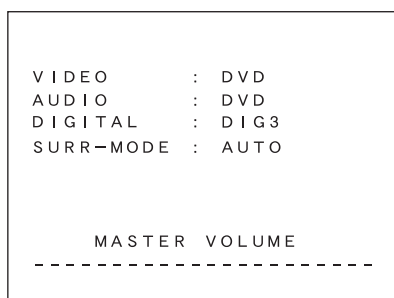

**① VIDEO SOURCE:**

Displays the current video source being selected with the function selector **TV, DVD, VCR1, DSS** or **AUX**.

**② AUDIO SOURCE:**

Displays the current audio source being selected with the function selector **FM, AM (MW, LW), CD, TAPE, CD-R, TV, DVD, VCR1, DSS** or **AUX**.

**③ DIGITAL INPUT:**

Displays the digital input that you are using **DIG-1, DIG-2, DIG-3** or **DIG-4**.

**④ SURROUND MODE:**

Displays the current surround mode **AUTO, STEREO, 6CH STEREO, VIRTUAL, MATRIX, STADIUM, HALL, MOVIE, CS5.1, 6.1 CH SURR, PLO LOGIC, PLII MUSIC, PLII MOVIE, DTS**

**⑤ MASTER VOLUME**

Displays the current volume level. The volume level is higher at the right of the display.

**Note:**

The On-Screen Display signals can be output from the TV MONI composite video (RCA) output and the TV MONI, S-Video output jacks.

With some video equipment or software, the On-Screen Display characters may be distorted due to noise or tracking adjustment error.

## 2. FUNCTION SELECT & SURROUND MODE

When a function selector button or surround mode button is pressed

**VIDEO:** Displays the current video source. When TV, DSS, DVD, VCR1 or AUX is selected with the function selector, both AUDIO and VIDEO shows the same name.

**AUDIO:** Displays the current analog audio input source.

**DIGITAL:** Displays the current digital input source.

**SURR-MODE:** Displays the current Surround mode as follows;

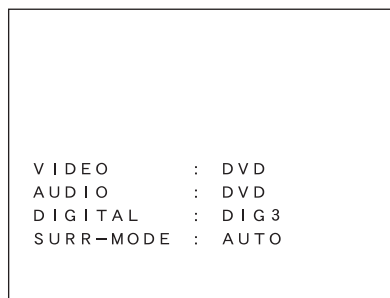
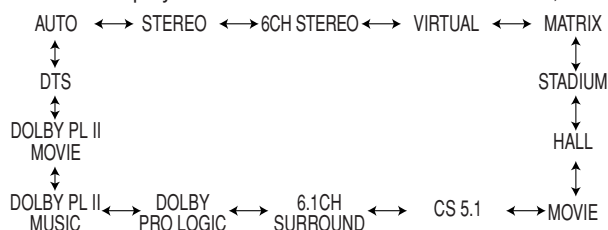

## 3. MASTER VOLUME CONTROL

Displayed when the MASTER volume is varied or a button of the remote control unit is pressed.

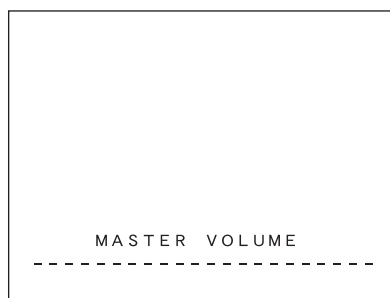



## 4. MUTE



When the **MUTE** button **[11/9]** is pressed, "MUTE ON" will be shown on screen.

Pressing **MUTE** button **[11/9]** again will show "MUTE OFF" on screen, and return to the previous volume level.



### 5. SLEEP TIMER

When the **SLEEP** button  /  is pressed, the setting on or off and the remaining time of the sleep timer function are displayed.

You can change the mode between on, off and the amount of time to elapse before the unit will shut itself off by cycling the **SLEEP** button  / .



### 6. OSD OFF

When **OSD** button  is pressed, OSD system will be bypassed after 3 seconds.

Then there is no indication on the TV display.

Press the **OSD** button  again to activate the OSD.



# SURROUND MODES

The SR6200 incorporates digital signal processors (DSP) which can reproduce various surround effects you experience in concert halls and movie theaters, etc. These Surround Modes, are provided to reproduce a variety of surround sound effects, according to the content of the source to be played.

Surround mode	FEATURES
1. <b>AUTO</b>	When this mode is selected, the receiver determines whether the digital input signal is Dolby Digital, PCM-audio or DTS. <b>Note:</b> When a Dolby Digital or DTS signal is input, the number of channels for which the corresponding signal is encoded will be played. Inputting a Dolby Digital two channel signal with Dolby surround status automatically subjects that signal to Pro Logic II processing before play. 96 kHz source material can be playback in this mode.
2. <b>STEREO</b>	This mode bypasses all surround processing. Stereo program sources the left and right channels play normaly when PCM-audio or analog stereo is input. With Dolby Digital and DTS sources, the 5.1 multi-channels are converted to two channel stereo. 96 kHz source material can be playback in stereo mode.
3. <b>DD</b>  <b>MOVIE</b> <b>MUSIC</b> <b>PRO LOGIC</b>	This mode is used with source materials encoded in Dolby Digital and Dolby Surround. Dolby Pro Logic II brings the excitement of surround sound to any stereo mix, while making existing Dolby Surround mixes sound more like discrete 5.1 channels Surround sound. Dolby Pro Logic II has below 3 modes.  This mode provides 5.1 channel surround sound from Dolby Surround encoded stereo movie sound tracks.  This mode provides 5.1 channel surround sound from conventional stereo sources, analog or digital, such as CD, tape, FM, TV, stereo VCR, etc.  This mode emulated original Dolby Pro Logic decoding (3/1 surround) suit for Dolby Surround encoded stereo movie soundtracks. <b>Note:</b> PCM-audio signals can be subjected to Pro Logic processing when the sampling frequency is 32 kHz, 44.1 kHz or 48 kHz. When a signal in another format is input, output will be muted.
4. <b>DTS</b>	This mode is for DTS encoded source materials such as LASER DISC, CD, and DVD. The DTS mode cannot be used when an Analog input has been selected. When the signal in another digital format is input, output will be muted.
5. <b>6.1CH Surround</b>	This mode reproduces 6.1 channel sound field by extracting the surround center information from surround left and surround right channels. This mode is suited for 6.1 channel encoded material such as Dolby Digital Surround EX and DTS-ES. <b>Note:</b> Dolby Digital 5.1ch and DTS source material can be playback in this mode.
6. <b>MOVIE HALL STADIUM MATRIX</b>	These modes provide surround effect processing from each input source material. They will produce theater, concert hall and stadium like atmospheres. Select as your taste desires. <b>Note:</b> PCM-audio (32 kHz, 44.1 kHz or 48 kHz) and analog source material can playback in this mode.
7. <b>VIRTUAL</b>	This mode create the virtual surround sound with the front right and left speakers. <b>Note:</b> The 96 kHz sampling frequency and DTS source material mute output.
8. <b>CS5.1</b>	This mode is backward compatible, such that surround sound playback is possible from any stereo or passive matrix-encoded material. Five full-bandwidth, discrete channels of information can be extracted from an enormous library of material not encoded in Dolby Digital or DTS. <b>Note:</b> PCM-audio (32 kHz, 44.1 kHz or 48 kHz) and analog source material can play back in this mode.
9. <b>6CH STEREO</b>	This mode is used to create a wider, deeper and more natural soundstage from two channel source material. This is done by feeding the left channel signal to both left front and left surround speaker and the right channel signal to both right front and right surround speaker. Additionally, the center channel reproduces a mix of the right and left channel. <b>Note:</b> The 96 kHz sampling frequency mutes output.

**Caution for DTS signal:**

This signal can be played when the connected DVD-player, laser-disc player or CD-player is capable of DTS-digital output. For details, refer to the player's operation manual.

Depending on the player used, DTS play may produce noise. If that happens, set the Surround mode to DTS.

Playing a DTS-CD or DTS laser disc causes the player's analog output terminal to output noise. Before playing DTS sources, be sure to connect the player's digital output to the SR6200's digital input. Be careful when connecting the output of these players to analog audio input.

Note that the SR6200 has the following restrictive functions built in to reduce noise emission as much as possible.

If DTS is selected while in the Surround mode, digital input cannot be switched to analog input. When the analog input function has been selected, Surround mode cannot be switched to DTS.

While signals from DTS-laser disc or CD are playing in another Surround mode, you cannot switch to digital input or from digital input to analog input.

**Caution for 96kHz PCM-audio signal:**

This signal can be played when a DVD-player or DAT-player connected to the SR6200 is capable of 96 kHz PCM output. For details, refer to the player's operation manual.

The signal can be played when STEREO or AUTO has been selected for the Surround mode.

Some DVD formatted discs featured copy protect. When use such disc, 96 kHz PCM signal is not output from the DVD player. For details, refer to the player's operation manual.

### The relation between the selected surround mode and the input signal

The surround mode is selected with the surround mode selector knob of the SR6200 or the remote control unit. However, the sound from the speakers depend upon the relationship between the selected surround mode and the input signal. They are as follows;

Surround Mode	Input Signal	Output					Fluorescent Indicator			
		L/R	SL/SR	C	SC	SW	Input Indicator	Format Status & Surround Mode	Temporary Display Status	Ch. Status
Auto	Dolby Digital (5.1ch)	O	O	O	-	O	DIGITAL	DOLBY, DIGITAL, AUTO	>AUTO>	L,C,R,SL,SR,LFE
	Dolby Digital (2ch)	O	-	-	-	O	DIGITAL	DOLBY, DIGITAL, AUTO	>AUTO>	L,R
	Dolby Digital (2ch:Lt/Rt)	O	O	O	-	O	DIGITAL	DOLBY, DIGITAL, PRO LOGIC, AUTO	>AUTO>	L,R,SC
	96kHz PCM	O	-	-	-	-	DIGITAL	PCM, STEREO, AUTO	>AUTO>96kHz>	L,R
	PCM(Audio)	O	-	-	-	O	DIGITAL	PCM, STEREO, AUTO	>AUTO>	L,R
	Analog	O	-	-	-	O	ANALOG	STEREO, AUTO	>AUTO>	-
Stereo	DTS (5.1ch)	O	O	O	-	O	DIGITAL	DTS, AUTO	>AUTO>	L,C,R,SL,SR,LFE
	Dolby Digital (5.1ch)	O	-	-	-	O	DIGITAL	DOLBY, DIGITAL, STEREO	>STEREO>	L,C,R,SL,SR,LFE
	Dolby Digital (2ch)	O	-	-	-	O	DIGITAL	DOLBY, DIGITAL, STEREO	>STEREO>	L,R
	Dolby Digital (2ch:Lt/Rt)	O	-	-	-	O	DIGITAL	DOLBY, DIGITAL, STEREO	>STEREO>	L,R,SC
	96kHz PCM	O	-	-	-	-	DIGITAL	PCM, STEREO	>STEREO>96kHz>	L,R
	PCM(Audio)	O	-	-	-	O	DIGITAL	PCM, STEREO	>STEREO>	L,R
Movie	Analog	O	-	-	-	O	ANALOG	STEREO	>STEREO>	-
	DTS (5.1ch)	O	-	-	-	O	DIGITAL	DTS, STEREO	>STEREO>	L,C,R,SL,SR,LFE
	Dolby Digital (5.1ch)	O	O	O	-	O	DIGITAL	DOLBY, DIGITAL	>DOLBY D>	L,C,R,SL,SR,LFE
	Dolby Digital (2ch)	O	O	O	-	O	DIGITAL	DOLBY, DIGITAL, PRO LOGIC	>PLII MOVIE>	L,R
	Dolby Digital (2ch:Lt/Rt)	O	O	O	-	O	DIGITAL	DOLBY, DIGITAL, PRO LOGIC	>PLII MOVIE>	L,R,SC
	96kHz PCM	-	-	-	-	-	DIGITAL	(PCM), DOLBY, PRO LOGIC	>PLII MOVIE>96kHz>	-
Music	PCM(Audio)	O	O	O	-	O	DIGITAL	PCM, DOLBY, PRO LOGIC	>PLII MOVIE>	L,R
	Analog	O	O	O	-	O	ANALOG	DOLBY, PRO LOGIC	>PLII MOVIE>	-
	DTS (5.1ch)	-	-	-	-	-	DIGITAL	(DTS), DOLBY, PRO LOGIC	>PLII MOVIE>	-
	Dolby Digital (5.1ch)	O	O	O	-	O	DIGITAL	DOLBY, DIGITAL	>DOLBY D>	L,C,R,SL,SR,LFE
	Dolby Digital (2ch)	O	O	O	-	O	DIGITAL	DOLBY, DIGITAL, PRO LOGIC	>PLII MUSIC>	L,R
	Dolby Digital (2ch:Lt/Rt)	O	O	O	-	O	DIGITAL	DOLBY, DIGITAL, PRO LOGIC	>PLII MUSIC>	L,R,SC
Pro Logic	96kHz PCM	-	-	-	-	-	DIGITAL	(PCM), DOLBY, PRO LOGIC	>PLII MUSIC>96kHz>	-
	PCM(Audio)	O	O	O	-	O	DIGITAL	PCM, DOLBY, PRO LOGIC	>PLII MUSIC>	L,R
	Analog	O	O	O	-	O	ANALOG	DOLBY, PRO LOGIC	>PLII MUSIC>	-
	DTS (5.1ch)	-	-	-	-	-	DIGITAL	(DTS), DOLBY, PRO LOGIC	>PLII MUSIC>	-
	Dolby Digital (5.1ch)	O	O	O	-	O	DIGITAL	DOLBY, DIGITAL	>DOLBY D>	L,C,R,SL,SR,LFE
	Dolby Digital (2ch)	O	O	O	-	O	DIGITAL	DOLBY, DIGITAL, PRO LOGIC	>PRO LOGIC>	L,R
DTS	Dolby Digital (2ch:Lt/Rt)	O	O	O	-	O	DIGITAL	DOLBY, DIGITAL, PRO LOGIC	>PRO LOGIC>	L,R,SC
	96kHz PCM	-	-	-	-	-	DIGITAL	(PCM), DOLBY, PRO LOGIC	>PRO LOGIC>96kHz>	-
	PCM(Audio)	O	O	O	-	O	DIGITAL	PCM, DOLBY, PRO LOGIC	>PRO LOGIC>	L,R
	Analog	O	O	O	-	O	ANALOG	DOLBY, PRO LOGIC	>PRO LOGIC>	-
	DTS (5.1ch)	-	-	-	-	-	DIGITAL	(DTS), DOLBY, PRO LOGIC	>PRO LOGIC>	-
	Dolby Digital (5.1ch)	-	-	-	-	-	DIGITAL	(DOLBY, DIGITAL), DTS	>DTS>	-
6.1Ch Surround	Dolby Digital (2ch)	-	-	-	-	-	DIGITAL	(DOLBY, DIGITAL), DTS	>DTS>	-
	Dolby Digital (2ch:Lt/Rt)	-	-	-	-	-	DIGITAL	(DOLBY, DIGITAL), DTS	>DTS>	-
	96kHz PCM	-	-	-	-	-	DIGITAL	(PCM), DTS	>DTS>	-
	PCM(Audio)	-	-	-	-	-	DIGITAL	(PCM), DTS	>DTS>	-
	Analog	-	-	-	-	-	(ANALOG)	DTS	>DTS>	-
	DTS (5.1ch)	O	O	O	-	O	DIGITAL	DTS	>DTS>	L,C,R,SL,SR,LFE
Movie Hall Stadium Matrix	Dolby Digital (5.1ch)	O	O	O	O	O	DIGITAL	DOLBY, DIGITAL	>6.1 CH SURROUND>	L,C,R,SL,SR,LFE
	Dolby Digital (2ch)	-	-	-	-	-	DIGITAL	(DOLBY, DIGITAL)	>6.1 CH SURROUND>	-
	Dolby Digital (2ch:Lt/Rt)	-	-	-	-	-	DIGITAL	(DOLBY, DIGITAL)	>6.1 CH SURROUND>	-
	96kHz PCM	-	-	-	-	-	DIGITAL	(PCM)	>6.1 CH SURROUND>	-
	PCM(Audio)	-	-	-	-	-	DIGITAL	(PCM)	>6.1 CH SURROUND>	-
	Analog	-	-	-	-	-	(ANALOG)	DTS	>6.1 CH SURROUND>	-
Virtual	DTS (5.1ch)	O	O	O	O	O	DIGITAL	DTS	>6.1 CH SURROUND>	L,C,R,SL,SR,LFE
	Dolby Digital (5.1ch)	-	-	-	-	-	DIGITAL	(DOLBY, DIGITAL), DSP SOUND	>MOVIE/HALL/ STADIUM/MATRIX>	-
	Dolby Digital (2ch)	-	-	-	-	-	DIGITAL	(DOLBY, DIGITAL), DSP SOUND	>MOVIE/HALL/ STADIUM/MATRIX>	-
	Dolby Digital (2ch:Lt/Rt)	-	-	-	-	-	DIGITAL	(DOLBY, DIGITAL), DSP SOUND	>MOVIE/HALL/ STADIUM/MATRIX>	-
	96kHz PCM	-	-	-	-	-	DIGITAL	(PCM), DSP SOUND	>MOVIE/HALL/ STADIUM/MATRIX>	-
	PCM(Audio)	O	O	O	-	O	DIGITAL	PCM, DSP SOUND	>MOVIE/HALL/ STADIUM/MATRIX>	L,R
CSS.1	Analog	O	O	O	-	O	ANALOG	DSP SOUND	>MOVIE/HALL/ STADIUM/MATRIX>	-
	DTS (5.1ch)	-	-	-	-	-	DIGITAL	(DTS), DSP SOUND	>MOVIE/HALL/ STADIUM/MATRIX>	-
	Dolby Digital (5.1ch)	O	-	-	-	-	DIGITAL	DOLBY, DIGITAL, VIRTUAL	>VIRTUAL>	L,C,R,SL,SR,LFE
	Dolby Digital (2ch)	O	-	-	-	-	DIGITAL	DOLBY, DIGITAL, PROLOGIC, VIRTUAL	>VIRTUAL>	L,R
	Dolby Digital (2ch:Lt/Rt)	O	-	-	-	-	DIGITAL	DOLBY, DIGITAL, PROLOGIC, VIRTUAL	>VIRTUAL>	L,R,SC
	96kHz PCM	-	-	-	-	-	DIGITAL	(PCM)	>VIRTUAL>96kHz>	-
6CH Stereo	PCM(Audio)	O	-	-	-	-	DIGITAL	PCM, DOLBY, PROLOGIC, VIRTUAL	>VIRTUAL>	L,R
	Analog	O	-	-	-	-	ANALOG	DOLBY, PROLOGIC, VIRTUAL	>VIRTUAL>	-
	DTS (5.1ch)	-	-	-	-	-	DIGITAL	(DTS), DOLBY, VIRTUAL	>VIRTUAL>	-
	Dolby Digital (5.1ch)	-	-	-	-	-	DIGITAL	(DOLBY, DIGITAL)	>CSS.1>	-
	Dolby Digital (2ch)	-	-	-	-	-	DIGITAL	(DOLBY, DIGITAL)	>CSS.1>	-
	Dolby Digital (2ch:Lt/Rt)	-	-	-	-	-	DIGITAL	(DOLBY, DIGITAL)	>CSS.1>	-
6CH Stereo	96kHz PCM	-	-	-	-	-	DIGITAL	(PCM)	>CSS.1>96kHz>	-
	PCM(Audio)	O	O	O	-	O	DIGITAL	PCM	>CSS.1>	L,R
	Analog	O	O	O	-	O	ANALOG	PCM	>CSS.1>	-
	DTS (5.1ch)	-	-	-	-	-	DIGITAL	(DTS)	>CSS.1>	-
	Dolby Digital (5.1ch)	O	O	O	-	O	DIGITAL	DOLBY, DIGITAL	>6CH STEREO>	L,C,R,SL,SR,LFE
	Dolby Digital (2ch)	O	O	O	O	O	DIGITAL	DOLBY, DIGITAL	>6CH STEREO>	L,R
6CH Stereo	Dolby Digital (2ch:Lt/Rt)	O	O	O	O	O	DIGITAL	DOLBY, DIGITAL	>6CH STEREO>	L,R,SC
	96kHz PCM	-	-	-	-	-	DIGITAL	(PCM)	>6CH STEREO>96kHz>	-
	PCM(Audio)	O	O	O	O	O	DIGITAL	PCM	>6CH STEREO>	L,R
	Analog	O	O	O	O	O	ANALOG	PCM	>6CH STEREO>	-
	DTS (5.1ch)	O	O	O	-	O	DIGITAL	DTS	>6CH STEREO>	L,C,R,SL,SR,LFE

L/R : Front speaker ( ) : The indicator blinks

SL/SR : Surround speaker

C : Center speaker

SC : Surround center speaker

SW : Sub woofer speaker

L : Left

R : Right

C : Center

SL : Surround Left

SR : Surround Right

SC : Mono Surround

LFE : Low Frequency Effect

**Note:**

- Dolby Digital (2 ch: Lt/Rt): signal with Dolby Surround flag Speakers are full set.
- When DOLBY DIGITAL, DTS, PCM or ANALOG is blinking, the selected surround mode is unavailable for input signal. Select the other appropriate surround mode to playback.
- No sound outputs from the surround speaker, center speaker and subwoofer if the DVD disc has no surround data.

# TROUBLE SHOOTING

In case of trouble, check the following before calling for service:

1. Are the connections made properly ?
2. Are you operating the unit properly following user's guide ?
3. Are the power amplifiers and speaker working properly ?

If the unit does not operate properly, check items shown in the following table.

If your trouble cannot be recovered with the remedy actions listed in the following table, malfunction of the internal circuitry is suspected; immediately unplug the power cable and contact your dealer, nearest Marantz distributor or the Marantz Service Center in your country.

SYMPTOM	CAUSE	REMEDY
SR6200 cannot be turned up.	The power plug is not connected.	Connect the power plug to the outlet.
No sound and picture are output even when power is on.	Mute is on. The input cable is not connected correctly. The master volume control is turned all the way down. The function selector position is wrong.	Cancel mute using the remote control unit. See the connection diagram and connect the cables correctly. Adjust the master volume. Select correct position.
Speaker does not outputting any sound.	The headphones are connected to the headphone jack.	Disconnect the headphones. (Speakers will not output sound when headphones are connected.)
Sound and pictures from other than equipment selected with the function selector.	Input cable connected incorrectly.	Connect the cable correctly by referring to the connection diagram.
Sound from the wrong channel is output from the speaker.	Speaker cable connected incorrectly.	Connect the cable correctly by referring to the connection diagram.
No sound is output from the center speaker.	The center speaker cable connection is incomplete. STEREO has been selected for Surround mode.  Center = NONE has been selected in SETUP mode.	Connect the cable correctly. When STEREO is selected for Surround mode, no sound will be output from the center speaker. Set another Surround mode. Make the correct setting.
No sound is output from the surround speakers.	The surround speaker cable connection is incomplete. STEREO has been selected for Surround mode.  Surround = NONE has been selected in SETUP mode.	Connect the cable correctly. When STEREO has been selected for Surround mode, no sound will be output from the surround speaker. Set another Surround mode. Make the correct setting.
No output to Sub Woofer Out.	Sub-woofer = NO has been selected in SETUP mode.	Select Sub-woofer = YES.
Surround mode cannot be changed.	The headphones are connected to the jack.	Disconnect the headphones. (When headphones are connected, Surround mode will be fixed to STEREO.)
Noise is produced during DTS-encoded CD or laser disc play.	Analog has been selected for input.	Be sure to perform digital connection, select digital input, then play.
DTS sources cannot be played.	Surround mode is set to DOLBY. The DVD or LD player is not DTS digital out capable.	Select other mode. Use a player which responds to DTS-digital out.
Player skips during play of a DTS source and produces noise.	Data error occurred during player skip.	Set Surround mode to DTS.
A 96kHz PCM signal cannot be played.	The disc player is not 96kHz PCM digital out capable. Surround mode is set to other than STEREO and AUTO.	Use a player that responds to 96kHz PCM digital out. Set Surround mode to STEREO or AUTO.
A normal PCM signal (CD or laser disc) cannot be played.	Surround mode is set to DTS.	Select other mode.
A Dolby Digital signal cannot be played.	Surround mode is set to DTS	Select other mode.
A specific channel does not produce output.	Nothing recorded on source.	Check the encoded channel on the source side.
FM or AM reception fails.	Antenna connection is incomplete.	Correctly connect the indoor FM and AM antennas to FM and AM antenna outlets.
Noise is heard during AM reception.	Reception is affected by other electrical fields.	Try changing location where the AM indoor antenna is set up.
Noise is heard during FM reception.	The radio waves from the broadcasting station are weak.	Install an FM outdoor antenna.
Cannot get programmed station when the PRESET button is pressed.	Preset data has been erased.	Disconnecting power plug for long periods of time will erase preset data. If that happens, input the preset data again.
Nothing appears on the remote commander display.	Batteries are consumed.	Replace all the batteries with new ones.
Control with the remote control unit fails.	Batteries are consumed.. Remote controller's function-key setting is wrong. The distance between this SR6200 and the remote commander is too far. Something is blocking SR6200 and the remote commander.	Replace all the batteries with new ones.. Select different position from which equipment will be controlled. Move closer to this SR6200.  Remove offending object.

**GENERAL MALFUNCTION**

If the equipment malfunctions, this may be because an electrostatic discharge or AC line interference has corrupted the information in the equipment memory circuits. Therefore:

- disconnect the plug from the AC line supply
- after waiting at least three minutes, reconnect the plug to the AC line supply
- re-attempt to operate the equipment

**Memory backup**

- In case a power outage occurs or the power cord is accidentally unplugged, the SR6200 is equipped with a backup function to prevent memory data such as the preset memory from being erased.

The memory functions are backed up for up to about one week.

**NOTE:**

First of all keep SR6200 Standby or Powered-on more than 6 hours, to sufficient time for memory back up.

# TECHNICAL SPECIFICATIONS

## FM TUNER SECTION

Frequency Range .....	87.5 - 108.0 MHz
Usable Sensitivity .....	IHF 1.8 $\mu$ V/16.4 dBf
Signal to Noise Ratio .....	Mono/Stereo 76/72 dB
Distortion .....	Mono/Stereo 0.2/0.3 %
Stereo Separation .....	1 kHz 45 dB
Alternate Channel Selectivity .....	$\pm$ 300 kHz 60 dB
Image Rejection .....	98 MHz 70 dB
Tuner Output Level .....	1 kHz, $\pm$ 40 kHz Dev 800 mV

## AM TUNER SECTION

Frequency Range .....	LW: 152 - 282 kHz, MW: 522 - 1611kHz
Signal to Noise Ratio .....	50 dB
Usable Sensitivity .....	Loop 400 $\mu$ V/m
Distortion .....	400 Hz, 30 % Mod. 0.5 %
Selectivity .....	$\pm$ 18 kHz 60 dB

## AUDIO SECTION

Continuous Power Output (8 ohms / 20 Hz - 20 kHz)	
Front .....	110W
Center .....	110W
Surround .....	110W
THD Front (20 Hz - 20 kHz) .....	8 ohms 0.05 %
Input Sensitivity/Impedance	
Linear .....	340 mV/ 47 Kohms
Signal to Noise Ratio	
Linear .....	105 dB

## VIDEO

Television Format .....	NTSC/PAL
Input Level/Impedance .....	1 Vp-p/ 75 ohms
Output Level/Impedance .....	1 Vp-p/ 75 ohms
Video Frequency Response .....	5 Hz to 8 MHz (- 1 dB)
S/N .....	60 dB

## GENERAL

Power Requirement .....	AC 230 V 50 Hz
Power Consumption (STEREO MODE RATED POWER) .....	350 W
Dimension (MAX)	
Width .....	440 mm
Height .....	164 mm
Depth .....	400 mm
Weight .....	14.8 Kg

## ACCESSORIES

Remote Control Unit RC6200SR .....	1
AAA-size batteries .....	2
FM Feeder Antenna .....	1
FM Antenna Converter .....	1
AM Loop Antenna .....	1
Registration Card .....	1
User Guide .....	1

Specifications subject to change without prior notice.

COUNTRY	COMPANY	ADDRESS
ALGERIE	Azur 2000	8, Lotissement Ben Hatadi, Alger, Algeria
ARMENIA	NGYIG Ltd.	47 A/75 St. Lalaiants, 375000 Yerevan, Armenia
AUSTRALIA	Jamo Australia Pty. Ltd.,	24 Lionel Road, Mt. Waverley, VIC 3149, Australia
AUSTRIA	Huber & Prohaska GmbH	Taborstraße 95 / Ladestraße 1, Gebäude Hangartner, A-1200 Wien, Austria
BAHREIN	Ambassador Stores	P.O. Box 237,141, Government Avenue, Manama,Bahrein
BANGLADESH	Target	1078, Ramjoy Mohanja Lane Asadgonj, Chittagong 4000, Bangladesh
BELGIUM	Van der Heyden Audio N.V.	Brusselbaan 278, 9320 Erembodegem, Belgium
BULGARIA	Ariescommerce GmbH	Makedonia Blvd. 16, 1606 Sofia, Bulgaria
CANADA	Lenbrook Industries Limited	633 Granite Court, Pickering, Ontario
CHINA	Guang Chang Audio International Co., Ltd.	No.38 Yushan Road, ShiQiao, Pan Yu, Guang Dong, China
CYPRUS	Empire Hifi systems Ltd.	P.O. Box 5604, Nicosia, Cyprus
CZECH REPUBLIC	Audio International	Sokolska 41, 67902 Rajecko, OKR,Blansko, Czech Republic
DENMARK	Audio Nord	Dali Allé 1, 9610 Noerager, Denmark
DUBAI	V.V. & SONS	P.O. Box 105, Dubai, U.A.E.
EGYPT	Solimco	9, El Attibaa St. Doki, Cairo, Egypt
ESTONIA	HiFi Club Estonia	Ehte 4, 90503 Haapsalu, Estonia
F.Y.R.O.M.	T.P. KODI	ul.Cedomir Kantargiev 21a, Skopje, Former Yugoslavian Republic of Macedonia
FINLAND	Audio Nord	Uudenmaankatu 4-6, Helsinki SF-00120, Finland
FRANCE	Marantz France	A division of Marantz Europe B.V., P.O. Box 301, 92 156 Suresnes Cedex, France
GERMANY	Marantz Deutschland	Hakenbusch 3, 49078 Osnabrück, Germany
GREECE	Adamco S.A.	188, Hippocratous Street, 11471 Athens, Greece
HEADQUARTERS EUROPE:	Marantz Europe B.V.	Building SFF-2, P.O. Box 80002, 5600 JB Eindhoven, The Netherlands
HONG KONG	Marantz Asia Ltd.	Unit 1706, Metroplaza II, 223 Hing Fong Road, Kwai Fong, N.T., Kowloon, Hong Kong
HUNGARY	Infovox Ltd.	Terez Krt.31, 1067 Budapest, Hungary
ICELAND	ID Electronics Ltd.	Armula 38, 108 Reykjavik, Iceland
INDIA	NOVA Audio Private	8,Punam Co-op.Society 29/30 Road#5, Union Park MUMBAI 400052, India
IRAN	Home Co.	5th floor no 878 Philips Building Enghelab ave, P.O. 11365/7844 Tehran, Iran
IRELAND	Marantz Ireland	Clonskeagh, Dublin 14, Ireland
ISRAEL	Elmor Ltd.	52 Heh Beiyar Street, Kikar Hamedina, Tel Aviv, Israel
ITALY	Marantz Italy	Via Casati 23, 20052 Monza (Milano), Italy, Servizio Consumatori 1678-20026, Numero Verde
IVORY COAST	Hifivoir	B.P. 2428, Abidjan 01, Ivory Coast
JAPAN	Marantz Japan Inc.	35-1 Sagami Ohno 7-Chome, Sagamihara-shi, Kanagawa 228-8505, Japan
KOREA	Mk Enterprises Ltd.	121-210, 2F Shinhan Bldg., 247-17 Seokyo-dong, Mapo-ku, Seoul, Korea
KUWAIT	alAlamiah Electronics Intl.	P.O. Box 8196, Salmiah 22052, Kuwait
LATVIA	Ace Ltd.	61, LacPlesa Str., Riga LV 1011, Latvia
LEBANON	AZ Electronics S.A., 1,	P.O. Box 11 2833, Beirut, Lebanon
LITHUANIA	Accapella Ltd.	Ausros, Vartu G/5, Pasazo SKG., 2001 Vilnius, Lithuania
MALAYSIA	Wo Kee Hong Electronics Sdn. Bhd.	Suite 8.1, Level 8, Menara Genesis, No. 33, Jalan Sultan Ismail, 50250 Kuala Lumpur, Malaysia
MALTA	Doneo Co Ltd.	78 The Strand, Sliema SLM07, Malta
MAURITIUS	SKR Electronics Ltd.	P.O. Box 685, Bell Village, Port Louis, Mauritius
MILITARY MARKET EUROPE	PASCO GmbH	PO BOX 1280, Sandhausen 69200, Germany
NETHERLANDS	Marantz Domestic Sales	A division of Marantz Europe B.V., Building SFF2, P.O. Box 80002, 5600 JB Eindhoven, The Netherlands
NEW ZEALAND	Wildash Audio Systems	14 Malvern Road, Mt. Albert, Auckland, New Zealand
NORWAY	Audio Nord	Sandkerveien 64, Oslo 0483, Norway
OMAN	Mustafa & Jawad Trading CO.	P.O. Box 1918, Ruwi, Oman
POLAND	Philips Polska Sp. z.o.o.	Al.Jerozolimskie 195b, 02 222 Warszawa, Poland
PORTUGAL	Corel2	Comércio de Electrónica Lda., Av. Luís Bivar, No 85 A, 1050 Lisboa, Portugal
PROFESSIONAL EUROPE	Marantz Professional Products	Kingsbridge House, Padbury Oaks, 575-583 Bath Road, Longford, Middlesex UB7 0EH, U.K.
PROFESSIONAL U.S.A.	Marantz Professional Products	Distributed by: Superscope Technologies Inc., 1000 Corporate Blvd. Ste.D, Aurora, IL
QATAR	Almana & Partners W.W.L.	P.O. Box 49, Doha, Qatar
REUNION	Vision +	180 Rue du Marechal Leclerc, 97400 Saint Denis, Ile de la Reunion
ROMANIA	Nova Music Entertainment	5, Zagazului Str. Bl.1G,apt.18, sector 1,Bucharest, Romania
RUSSIA	Absolute Audio	7/2, Montazhnaya Street, 107497 Moscow, Russia
SAUDI ARABIA	Adawlia Univ. Electr. Apl	P.O. Box 2154, Alkhobar 31952, Saudi Arabia
SINGAPORE	Wo Kee Hong Distribution PTE Ltd.	130 Joo Seng Road, #03-02 Olivine Building, Singapore 368357
SLOVAKIA	Bis Audio s.r.o.	Nam. SNP 10, 96001 Zvolem, Slovakia
SLOVENIA	Bofex	Smartinska 152, HALA V/3, 61000 Ljubljana, Slovenia
SOUTH AFRICA	Coherent Imports (PTY) Ltd.	P.O. Box 1614, Alberton, 1450, South Africa
SPAIN	Marantz Spain	Martinez Villergas 2, Apartado 2065, Madrid 28027, Spain
SRI LANKA	The listening Room	Mezzanine Floor, The Landmark 385, Galle Road, Colombo - 3, Sri Lanka
SWEDEN	Audio Nord	Almedalsvagen 4, Gotenborg 402-23, Sweden
SWITZERLAND	Sound Company AG	Postfach, 8010 Zürich, Switzerland
SYRIA	Hamzeh & Partners	Hafez Ibrahim Str. No 117, Damascus Shalan, Syria
TAHITI	Covecolor	Av. Prince Hinoi, Cours de l'union sacré, P.O. Box 2334, Papeete, Tahiti
TAIWAN	Pai-Yuing Co. Ltd.	6th No 148 Sung Kiang Road, Taipei 10429, Taiwan R.O.C.
THAILAND	MRZ Standard Co. Ltd.	746-750 Mahachai Road, Wangburapa, Bangkok 10200, Thailand
TUNESIA	Societe EDEVIG	40, Avenue du Golfe Arabe, El Menzah, 1004, Tunesia
TURKEY	Türk Philips Ticaret A.S.	Yukari Dudullu Organize sanayi Bolgesi, 2.Cadde no.28, 81260 Umraniye-Istanbul, Turkey
U.K.	Marantz Hifi UK Ltd.	Kingsbridge House, Padbury Oaks, 575-583 Bath Road, Longford, Middlesex UB7 0EH, U.K.
U.S.A.	Marantz America Inc.	1100 Maplewood Drive Itasca, IL 60143, U.S.A.
YUGOSLAVIA	ITM Company	Omladinskih Brigada 86, 11070 Belgrade, Yugoslavia
EXPORT	Marantz Domestic Sales	A division of Marantz Europe BV,Building SFF2, P.O. Box 80002, 5600 JB Eindhoven, The Netherlands

www.marantz.com

Manufactured under license from Dolby Laboratories. "Dolby", "Pro Logic", and the double-D symbol are trademarks of Dolby Laboratories. Confidential unpublished works. Copyright 1992-1997 Dolby Laboratories. All rights reserved.

"DTS", "ES" and "DTS Digital Surround" are trademarks of Digital Theater Systems, Inc.

Circle Surround and the (●)® symbol are trademarks of SRS Labs, Inc.

Circle Surround technology is incorporated under license from SRS Labs, Inc.

